

EN-US Instructions for use for patients
For devices of type: LM150TD



LUISA

Ventilator for home environment

LÖWENSTEIN
medical

Contents

1 Introduction	3	7.6 Nurse call and remote alarm	25
1.1 Intended use	3	8 Troubleshooting	26
1.2 Description of function.....	3	9 Technical data	27
1.3 User qualification	3	9.1 Ambient conditions	27
1.4 Indications	4	9.2 Physical specifications and classifications.	27
1.5 Contraindications.....	4	9.3 Materials.....	27
1.6 Side effects.....	4	9.4 Electronics and physical interfaces	27
1.7 General information	4	9.5 Therapy.....	28
1.8 Clinical benefit.....	4	9.6 Noise	29
2 Safety	5	9.7 Batteries	29
2.1 Safety information	5	9.8 Software.....	30
2.2 Safety information in these instructions for use	6	9.9 Accessories.....	30
3 Product description	7	9.10 Accuracy of measuring devices used.....	30
3.1 Overview	7	9.11 SpO ₂ sensor	30
3.2 Display.....	8	10 Annex	31
3.3 Symbols in the display.....	8	10.1 Pneumatic diagram.....	31
3.4 Operating states	9	10.2 System resistances	33
3.5 Batteries	9	10.3 Emission of electromagnetic interference	33
3.6 Data management/compatibility.....	10	10.4 Electromagnetic interference immunity ...	33
3.7 Trolley 2.0.....	10	10.5 Markings and symbols.....	34
4 Preparation and operation	11	10.6 Scope of supply.....	35
4.1 Setting up and connecting device	11	10.7 Accessories and spare parts	35
4.2 Connect circuit	11	10.8 Declaration of Conformity.....	36
4.3 Before first use.....	12	10.9 Warranty.....	36
4.4 Switch device on and off / Start and end therapy	13		
4.5 Circuit test.....	13		
4.6 Performing SpO ₂ measurement	13		
4.7 Calibrating the FiO ₂ cell.....	14		
4.8 Pairing device with LUISA app.....	14		
4.9 Contaminated components.....	14		
5 Settings in the menu	15		
5.1 Navigating in the menu	15		
5.2 Menu structure	15		
6 Reprocessing and maintenance	17		
6.1 Hygiene treatment.....	17		
6.2 Function check	18		
6.3 Servicing.....	19		
6.4 Disposal.....	20		
7 Alarms	21		
7.1 General information	21		
7.2 Reacting to an alarm	21		
7.3 set alarms	21		
7.4 Physiological alarms.....	21		
7.5 Technical alarms	23		

1 Introduction

1.1 Intended use

The LM150TD ventilator is for the life-support and non-life-support ventilation of patients who require mechanical ventilation. It can be used for pediatric or adult patients with a minimum tidal volume of 30 ml.

The LM150TD is suitable for use in the domestic environment, in care facilities, and in hospitals, as well as for mobile applications, for example in a wheelchair or on a transport gurney. It can be used for invasive and non-invasive ventilation.

Non-specialist users with adequate training and specialist users can operate the device.

1.2 Description of function

The blower takes in ambient air through a filter and pumps it to the device outlet. From the device outlet, air flows through the patient circuit and the patient interface to the patient.

1.3 User qualification

The person operating the device is referred to in these Instructions for Use as the user. All users must receive training or instruction in how to operate the device. The device must only be used as specified in

Blower output is controlled and therapy pressure thus modified based on the signals detected by the pressure and flow sensors.

An external SpO₂ sensor can be connected to measure oxygen saturation and pulse rate.

On the leakage circuit, exhaled air containing CO₂ escapes via an exhalation system. On the single circuit with valve and on the double circuit, exhaled air containing CO₂ escapes via the patient valve on the circuit.

A FiO₂ cell can be fitted to measure the proportion of oxygen in the inhaled air.

Oxygen equipment can be connected.

The device is operated via the display, the on/off key, and the alarm acknowledgement key.

the training and instruction sessions. A distinction is made between **specialist users** (experts) and **lay users**, composed of the following groups of people:

Person	Description	User qualification
Patient	Person receiving treatment with no expert medical or nursing knowledge.	Following an introduction by a health-care professional in how the device works and how to use it, patients, relatives, and other caregivers are lay users .
Relatives and other caregivers	Person in a domestic environment supporting the patient with routine tasks and who has no expert medical or nursing knowledge.	
Owner/operator	Healthcare facility responsible for ensuring the compatibility of the device and of all the components or accessories associated with the patient before use (e.g., a hospital).	Following training by the manufacturer or by service personnel expressly authorized by the manufacturer in how the device works and how to use it, health institutions are specialist users .
Healthcare professional	Person with state-approved qualification in a medical profession (e.g., physicians, respiratory therapists, medical technicians).	Following training by the manufacturer or by trained health institutions in how the device works and how to use it, healthcare professionals and nurses are specialist users .
Nursing specialist	Person with state-approved qualification in a nursing profession.	
Service personnel	Person with state-approved qualification in a technical profession.	Following training by the manufacturer in how the device works and how to use it, service personnel are specialist users .
Specialist dealer	Person or organization that markets, but does not itself manufacture a product. The specialist dealer can provide a support function.	Following training by the manufacturer in how the device works and how to use it, specialist dealers are specialist users .

As an owner/operator or user, you must be familiar with the operation of this medical device.



For blind and partially-sighted users
An electronic version of the instructions for use is also available on the manufacturer's website.

1.4 Indications

Obstructive ventilation disorders (e.g. COPD), restrictive ventilation disorders (e.g. scolioses, deformities of the thorax), neurological, muscular, and neuromuscular disorders (e.g. types of muscular dystrophy, pareses of the diaphragm), central respiratory regulation disorders, obesity hypoventilation syndrome, hypoxic respiratory failure.

1.5 Contraindications

The following contraindications are known - in the individual case, responsibility for deciding whether to use the device rests with the healthcare professional. Threatening situations have not ever been observed.

Absolute contraindications: Severe epistaxis, high risk of barotrauma, pneumothorax or pneumomediastinum, pneumoencephalus, status following brain surgery and following surgical procedures on the hypophysis or middle or inner ear, acute inflammation of the nasal sinuses (sinusitis), middle ear infection (otitis media) or perforated eardrum. Mask ventilation must not be used in particular in the case of significant swallowing problems (bulbar syndrome) with the risk of aspiration.

Relative contraindications: Cardiac decompensation, severe cardiac arrhythmias, severe hypotension, especially in combination with intravascular volume depletion, head injury, dehydration.

1.6 Side effects

When using the device, the following undesired side effects may occur in short-term or long-term use: Pressure points from the mask and the forehead cushion on the face, reddening of the facial skin, dry throat, mouth, nose, feeling of pressure in the sinuses, irritated conjunctiva in the eyes, gastrointestinal insufflation of air ("bloating"), nosebleeds; muscular atrophy in the case of long-term ventilation. These are general side effects not attributable specifically to use of devices of type LM150TD.

1.7 General information

The device is a medical device which must only be used on the instruction and in accordance with the specifications of a healthcare professional.

In the EU: As a user and/or patient, you must report any serious incidents occurring in conjunction with the product to the manufacturer and to the responsible authority.

1.8 Clinical benefit

The clinical benefit for the patient is improved ventilation (improved blood gas values, relief of the airway musculature under strain).

NIV / IV / MPV in standard mode:

Restoring proper ventilation/regulation of breathing either via permanent settings or via automatic reactions to the patient's requirement, maintaining adequate gas exchange in the event of acute respiratory failure, relieving the respiratory pump/supporting the respiratory musculature, improving alveolar ventilation and blood gases, reducing sleepiness during the day, improving health-related quality of life and long-term prognosis of illness, reducing inpatient hospital stays/exacerbation of existing conditions.

Additional clinical benefit of HFT mode on the LM150TD:

Flushing out the dead space in the nasopharynx and reducing CO₂ level as a result, improving mucociliary clearance by moistening and warming the upper airway, improving oxygenation/gas exchange, administering a slight positive pressure to the upper airway, reducing the requirement for ventilation, respiratory work and respiratory distress, potentially reducing respiratory rate in spontaneous breathing.

2 Safety

2.1 Safety information

2.1.1 Energy supply

Operating the device outside the specified energy supply may cause personal injury, damage the device or impair the performance of the device.

- ⇒ All settings are retained in the event of a power outage.
- ⇒ Keep access to plug and power supply clear.
- ⇒ Operate the power supply unit only at voltages from 100 V to 240 V.
- ⇒ The device is intended for operation on voltages of 12 V, 24 VDC and 48 VDC.

2.1.2 Electromagnetic compatibility (EMC)

The device is subject to special precautions with regard to EMC (electromagnetic compatibility). If these precautions are not followed, the device may malfunction and individuals may be injured.

- ⇒ Do not operate the device if the housing, cables or other equipment for electromagnetic shielding are damaged.
- ⇒ Operate the device only within the EMC environment specified for this device (See [Resistance to electromagnetic interference](#) [▶ 33]) in order to prevent key performance characteristics being affected - for example, therapy parameters being affected by electromagnetic interference.
- ⇒ Portable high-frequency communication equipment (e.g., radios and cell phones), including their accessories such as antenna cables and external antennas, for example, must be used at a distance of at least 30 cm from the device and its cables.
- ⇒ The use of third-party accessories, third-party inverters, and third-party cables may lead to increased electromagnetic interference or reduced electromagnetic interference immunity of the device and to faulty operation. Only use the manufacturer's cables.
- ⇒ Do not use the device in the vicinity of active high-frequency surgical equipment.
- ⇒ Do not operate the device in the immediate vicinity of other devices or in a stacked arrangement, otherwise there may be malfunctions. If it is necessary to operate the device in the immediate vicinity of other devices or in a stacked arrangement, keep all the devices under observation to ensure that they are all operating properly

2.1.3 Ambient conditions

- ⇒ Only operate, store and transport the device under the specified ambient conditions (See [Ambient conditions](#) [▶ 27]).
- ⇒ If device and battery have been stored outside the quoted operating temperature, the device can only be started up once it has warmed up or cooled down to the permitted operating temperature (wait at least 4 hours).
- ⇒ Minimize the risks of the domestic setting (pests, dust, heat from heat sources etc.). Keep devices and device accessories away from children and pets.
- ⇒ Keep small parts which may be inhaled or swallowed away from young children in particular.
- ⇒ Do not use the device in an MRI environment or in a hyperbaric chamber.
- ⇒ Position non-medical equipment away from the patient's vicinity.

2.1.4 Therapy

- ⇒ Always keep an alternative ventilation option to hand in order to prevent a life-threatening situation if the device fails.
- ⇒ Ensure that the circuit and the patient interface are correctly and securely fitted.
- ⇒ The accuracy of the device may be impaired by the gas supplied by a nebulizer. Do not use or supply anesthetic gases.
- ⇒ Eliminate unintentional leakage on the breathing mask or circuit. In the event of unintentional leakage, the values displayed for volume will deviate from actual patient values.

2.1.5 Alarms

- ⇒ In order to react to an alarm and, if necessary, to perform emergency ventilation, subject both patient and device to regular monitoring.
- ⇒ Set alarm volume high enough for the alarm sound to be heard.
- ⇒ All alarm settings are retained in the event of a power outage.
- ⇒ Connection by cable to a patient monitor is not a substitute for a remote alarm system. Alarm data are transmitted only for documentation purposes.

2.1.6 Handling oxygen

Supplying oxygen without a special safety device can lead to fire and injure people.

- ⇒ Follow the Instructions for Use for the oxygen supply system.

- ⇒ Set up oxygen source at a distance of over 1 m from the device.
- ⇒ A healthcare professional specifies the oxygen dosage. The set oxygen flow must not exceed the specified oxygen flow.
- ⇒ At the end of therapy, shut off the oxygen equipment and allow the device to run on briefly to drive out any residual oxygen.
- ⇒ The oxygen flow supplied (in l/min) must not exceed the set HFT flow.

2.1.7 Wireless communication

The device contains components for wireless communication. Operating the device in the immediate vicinity of people and/or other antennas may injure people, damage the device or impair device performance.

- ⇒ Set up the device at least 20 cm away from any people.
- ⇒ Do not set up or operate the device with other antennas.

2.1.8 Cleaning and maintenance

Residues in the device and accessories or bacterial contamination of the device and accessories may cause infections and put the patient at risk.

- ⇒ Follow the section on reprocessing (See [Reprocessing](#) [▶ 17]).
- ⇒ Do not reuse disposables. Disposables may be contaminated and/or their function may be impaired.
- ⇒ Do not use the device, components, accessories, and spare parts if they are damaged or if the automatic function test issues error messages.
- ⇒ Perform a function check at regular intervals (at least every 6 months) (See [Function check](#) [▶ 18]).
- ⇒ Have actions such as servicing, maintenance, and repair work, as well as modifications to the product, carried out only by the manufacturer or by service personnel authorized by the manufacturer.

2.1.9 Accessories and spare parts

- ⇒ Only use accessories and spare parts quoted in these instructions for use. The products must meet the product standard applicable to them.
- ⇒ Only use accessories and spare parts from the manufacturer. Using third-party accessories and spare parts (third-party articles) voids any claim to warranty and liability.
- ⇒ Only connect accessory parts from the manufacturer intended for use with the device.
- ⇒ Do not use antistatic or electrically-conductive tubes.
- ⇒ Regularly check the breathing system filter for increased resistance and blockages. Use of nebulizers or humidifiers may increase the resistance of breathing system filters and thus change the ther-

apy pressure delivered. Replace breathing system filters more frequently to prevent increased resistance and blockages.

- ⇒ Set up external humidifiers below the device and below the patient connection port. Water in the device may damage the device or injure the patient.

2.1.10 Transport and mobile use





Operating the device in any kind of bag may impair device performance and injure the patient. Water and dirt in the device may damage the device.

- ⇒ Only operate the device in the associated mobility bag for mobile use.
- ⇒ Transport and store the device only in the associated protection bag.

2.1.11 SpO₂ measurement

- ⇒ Only use the SpO₂ sensors and cables quoted in these instructions for use (See [Accessories and spare parts](#) [▶ 35]).
- ⇒ For photodynamic treatments, note the peak values of wavelengths, optical output power, and the use (see instructions for use of the 8000SX sensor).
- ⇒ Check and, if possible, eliminate environmental influences that can impair the function or accuracy of the SpO₂ sensors: excessive periphery lighting, excessive movement, interference due to electro-surgical instruments, moisture in the sensor, incorrectly attached sensor, carboxyhemoglobin, restriction of the blood flow (due to arterial catheters, blood pressure cuffs, infusion lines, etc.), incorrect sensor type, poor pulse quality, venous pulse, anemia or low hemoglobin concentrations, cardiovascular dyes, dysfunctional hemoglobin, artificial fingernails or nail polish, residues (e.g., dried blood, dirt, oil, grease) in the light path.

2.2 Safety information in these instructions for use

-  **WARNING**
Indicates an unusually significant hazardous situation. If you ignore this instruction, severe irreversible or fatal injuries may result.
-  **CAUTION**
Indicates a hazardous situation. If you ignore this instruction, mild or moderate injuries may result.
-  **NOTICE**
Indicates a harmful situation. If you ignore this instruction, material damage may result.
-  **Information**
Indicates useful information and hints.

3 Product description

3.1 Overview

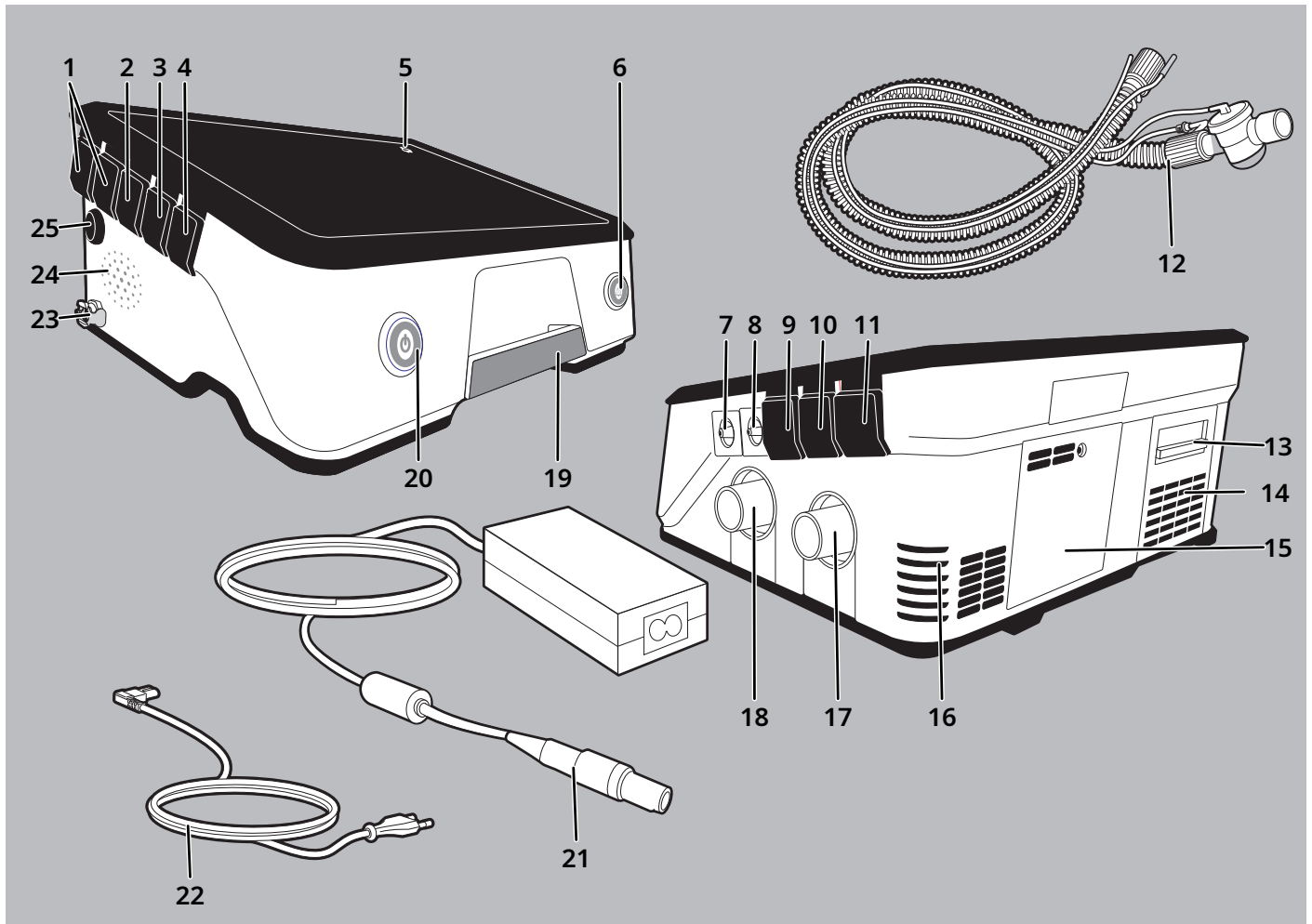

- | | | | |
|----|--|----|--|
| 1 | Connection for external batteries | 2 | Connection for monitor |
| 3 | Connection for USB-C | 4 | Remote alarm connection |
| 5 | Power supply indicator | 6 | Alarm acknowledgement key |
| 7 | Inlet port for pressure measuring tube | 8 | Inlet port for valve control tube |
| 9 | Inlet for SpO ₂ sensor | 10 | Inlet for CO ₂ measurement (not in use) |
| 11 | Inlet port for nebulizer (not in use) | 12 | Circuit (single circuit with valve) |
| 13 | Filter compartment with coarse dust filter and fine filter | 14 | Patient air intake area |
| 15 | Compartment for internal battery | 16 | Intake area for cooling fan |
| 17 | Device inlet port | 18 | Device outlet port |
| 19 | Handle | 20 | On/off key |
| 21 | Power supply unit with power cord | 22 | Power cord |
| 23 | O ₂ inlet | 24 | Loudspeaker |
| 25 | Connection for power supply unit | | |

3.2 Display

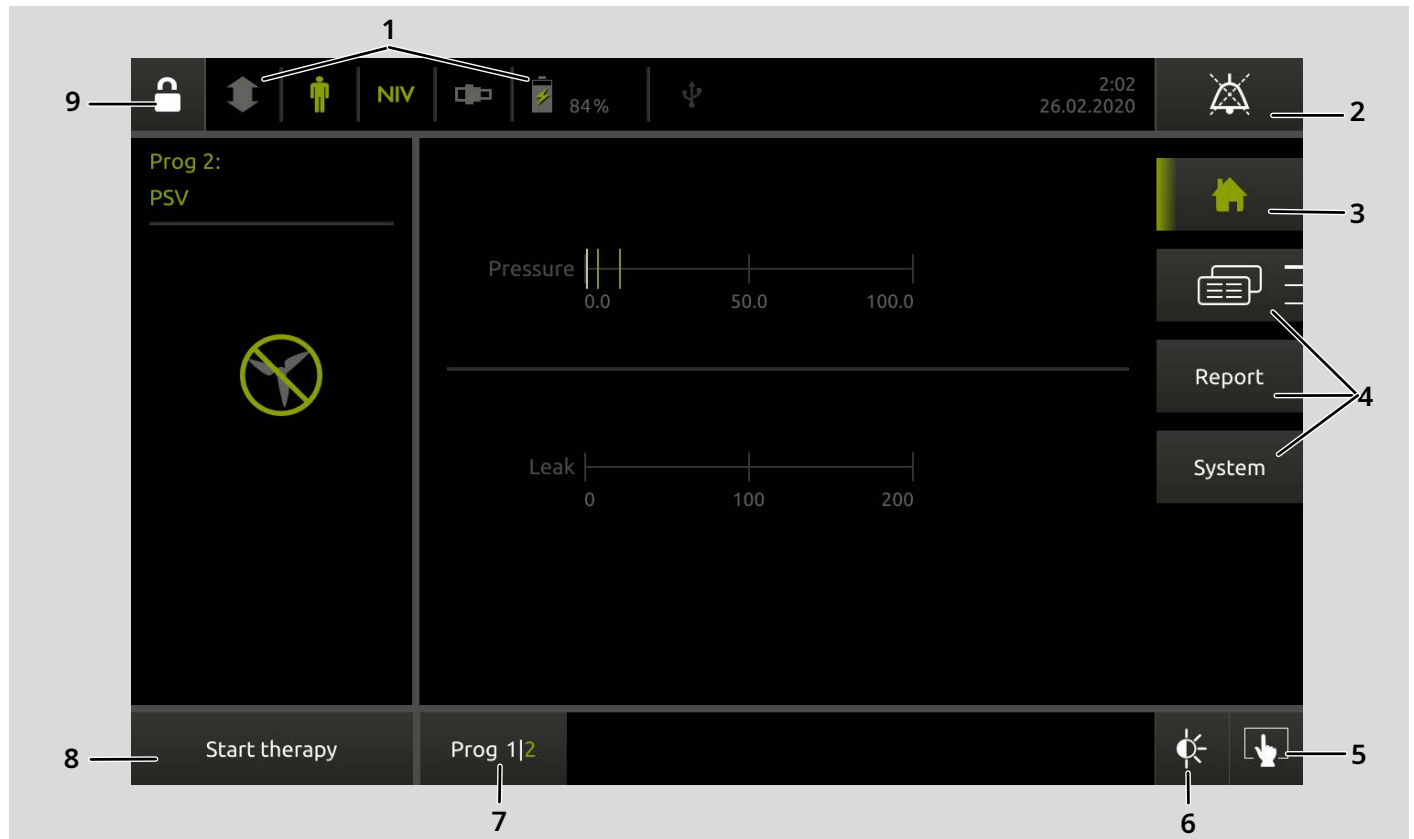





- 1 Status line - symbols indicate current device status (e.g. accessories connected, battery capacity).
- 2 Alarm acknowledgement key - acknowledges alarms and mutes alarms.
- 3 Home key - switches the view back to the home display.
- 4 Menu buttons - provide access to the individual menus.
- 5 Display lock key - locks or unlocks the display to prevent settings being made as a result of incorrect contact.
- 6 Dimmer key - the display goes dark. Touch the display to activate it. Keep key depressed to open the display menu.
- 7 Program key - provides access to the therapy programs.
- 8 Ventilation button - starts or stops ventilation.
- 9 Access button - locks or unlocks the Expert menu.

3.3 Symbols in the display

Symbol	Description
	Device in Patient menu. Expert menu locked.
	Device in Expert menu. Expert menu unlocked.
	Indicates respiratory status: - Arrow pointing upward: Inspiration - Arrow pointing downward: Exhalation - S: Spontaneous breath - T: Mandatory breath
	Device set for pediatric applications/children (restricted selection and setting of ventilation modes).
	Device set for adults.
	Invasive patient interface set.

Symbol	Description
	Non-invasive patient interface set.
	Leakage circuit set.
	Single circuit with valve set.
	Double circuit set.
	Battery discharging. - Green: Battery capacity high - Yellow: Battery capacity moderate - Red: Battery capacity low - Letter "I": Internal battery - Letter "E": External battery
	Battery charging. If the gray area reaches the top, the battery is fully charged.
	Battery defective

Symbol	Description
	Filter change (only if function is activated)
	Service reminder (only if function is activated)
	Alarm triggered - One symbol: Low priority - Two symbols: Medium priority - Three symbols: High priority
	Pause alarm sound.
	USB-C flash drive: • Green: Data transfer • Gray: Connected, no data transfer • Red: Defective
SpO₂	SpO ₂ sensor - Gray: Not connected - Green: Connected, high signal quality - Yellow: Connected, moderate signal quality - Red: Connected, poor signal quality
FiO₂	FiO ₂ cell - Green: Activated - Gray: Inactive and empty - Green and flashing: Calibration in progress
	Flight mode activated
	Bluetooth® (wireless technology) - Green: Activated, device connected - Gray: Not activated

3.4 Operating states

Operating status "On" and therapy in progress

- It is possible to make device and therapy settings.
- The on/off key is not illuminated.

After 10 minutes without operation, the display switches to a screensaver showing the pressure curve of the current therapy session. Touch the display or press the on/off key to interrupt the screensaver.

The screensaver stops as soon as there is an alarm message.

Operating status "On" and therapy not in progress

- It is possible to make device and therapy settings.
- The on/off key is illuminated.

After 10 minutes without operation, the display goes dark.

If the device is in battery mode and is not operated for 40 minutes, it switches off to save energy. The on/off key is not illuminated.

Operating state "Off"

The device is switched off. Therapy is not in progress. It is not possible to make device and therapy settings. The on/off key is not illuminated.

3.5 Batteries

3.5.1 Internal battery

The device is fitted with an internal battery.

If the device is disconnected from the power supply or there is a power outage, the internal battery starts supplying energy to the device. This discharges the internal battery.

The internal battery also discharges if the device is not connected to the power supply for an extended period.

If the device is always to be ready for use (internal battery charged), do not disconnect the device from the power supply.

The internal battery is replaced by the manufacturer or by the specialist dealer.

3.5.2 External battery

External batteries can be connected as an additional energy supply.

In battery mode, the external batteries connected are discharged first, followed by the internal battery.

3.5.3 Battery charging

Internal and external batteries are charged as soon as the device is connected to the power supply.

3.5.4 Battery life and battery capacity

Battery life depends on therapy settings and on ambient temperature (See [Ambient conditions](#) [▶ 27]). Battery life is reduced at low or high ambient temperatures.

Device life remaining in the case of battery and power supply operation is displayed in the status line and in the **Views** menu (See [Views menu](#) [▶ 15]). Remaining life is a prediction and always relates to the current mean consumption of the device.

Following the start of therapy, no more than 3 minutes will elapse before life remaining is displayed.

In the event of battery capacity alarms, the device will switch off within a few minutes (See [Alarms](#) [▶ 21]). Connect the device to the power supply as soon as battery capacity alarms occur.

If using battery supply, always keep an alternative ventilation option to hand.

3.6 Data management/compatibility

i The health institution is responsible for applying risk management to medical IT networks in accordance with IEC 80001-1. Medical IT networks are IT networks which incorporate at least one medical device.

The manufacturer does not accept any warranty or liability for interactions between system components within a medical IT network.

The manufacturer is not the system configurator.

3.6.1 Saving and transmitting therapy data

Therapy data for the previous 365 therapy days are saved in the device at high resolution of up to 100 Hz. Statistical data for the previous 12 months are likewise saved in the device.

Save therapy data to a USB-C flash drive

A file in .edf format is created for every therapy. When you connect a USB-C flash drive, the therapy and statistical data saved in the device are transmitted to the USB-C flash drive in the form of .edf files.

It is likewise possible to save a detailed data set (See [System menu](#) [▶ 16]).

The therapy data saved on the USB-C flash drive can be read into and displayed in the prismaTS software and prisma CLOUD.

3.6.2 Performing the firmware update

1. Connect a USB flash drive with an update file (at least one version higher than the current firmware version).
2. Confirm that the firmware update is to be performed.

i The firmware update also updates the batteries. The device configuration is retained following the firmware update.

3.7 Trolley 2.0

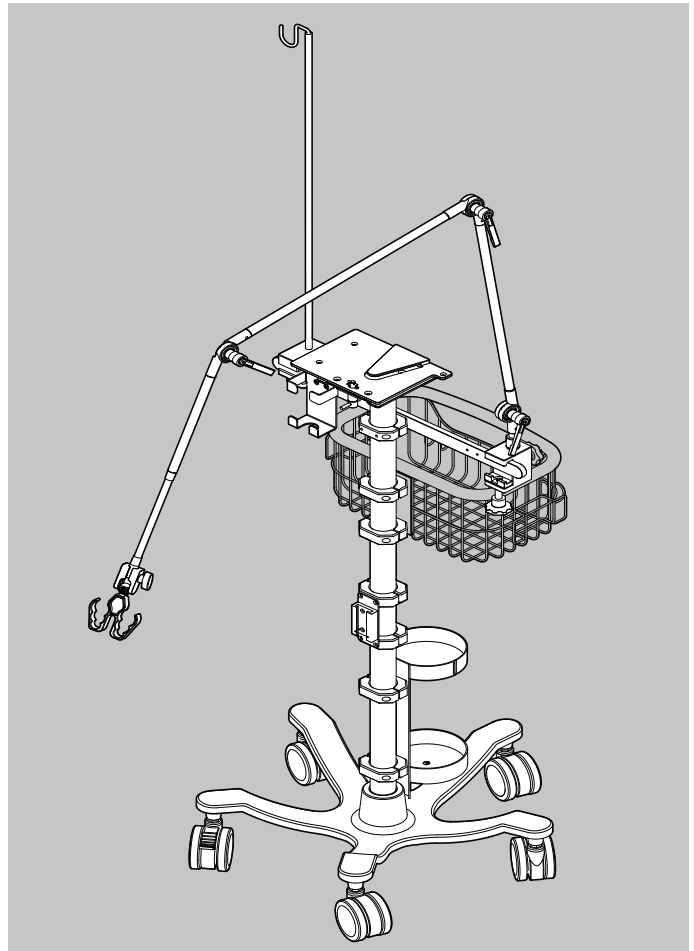

- ⚠ NOTICE**
Material damage if trolley 2.0 is not configured correctly!
If trolley 2.0 is not used properly, it may tip over or be damaged.
- ⇒ Follow assembly instructions. Configure the trolley in accordance with the manufacturer's instructions.
 - ⇒ Use trolley 2.0 only on a maximum incline of 10°.
 - ⇒ Ensure that the total weight of trolley 2.0 when fully equipped is < 25 kg.
 - ⇒ Before moving trolley 2.0: Fold away the circuit holder.

4 Preparation and operation

4.1 Setting up and connecting device

1. Place device freestanding on a level surface.
Caution! Risk of injury due to blocked air passages!

Observe the following safety precautions:

- Keep ventilation openings (☒ symbol) clear. Do not cover device with textiles (e.g. blankets or curtains).
- Do not set up the device in the immediate vicinity of a heat source.
- Do not expose device to direct sunlight.

1. Connect the power cord to the power supply unit and the socket.
2. Connect the power cord to the device.

i Alternatively, you can connect the device to a direct current power supply (12 VDC or 24 VDC) to ISO 80601-2-72.

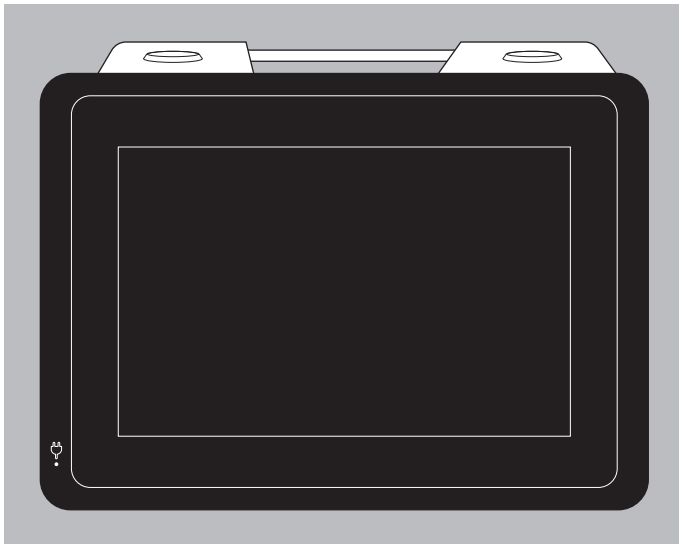

3. If required: Tilt the device to a horizontal or vertical position.
The display adapts to the orientation automatically.

4.2 Connect circuit



CAUTION

Risk of injury from incorrectly routed circuits and cables!

- ⇒ Do not route circuits and cables along the patient's neck.
- ⇒ Do not crush circuits and cables.

4.2.1 Connecting leakage circuit

1. If the patient interface or circuit is used without an integrated exhalation system, connect an external exhalation system (see instructions for use for exhalation system).

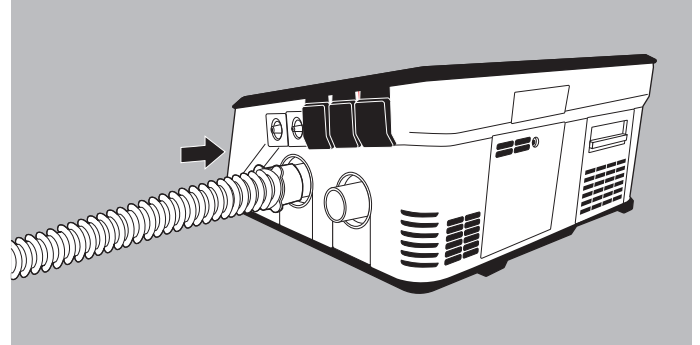

2. Push the inspiration tube onto the device outlet port.
3. Connect the patient interface (e.g. breathing mask) to the circuit.
4. Keep exhalation systems clear.

4.2.2 Connecting double circuit

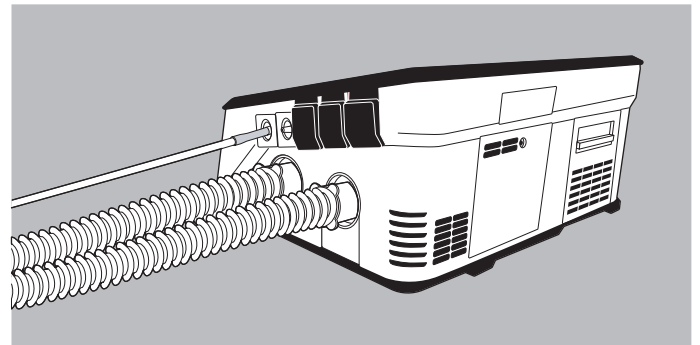

1. Push the inspiration tube onto the device outlet port.
2. Push the expiration tube onto the device inlet port.
3. Push the pressure measuring tube (blue marking) onto the inlet for the pressure measuring tube P_{-} .

- i** It is possible to use the device without a pressure measuring tube. Use without a pressure measuring tube must be selected during the circuit test.
4. Connect the patient interface (e.g. breathing mask) to the circuit.
 5. Keep exhalation systems clear.

4.2.3 Connecting single circuit with valve

- ! WARNING**
Risk of injury from limited disconnection detection!
If proximal pressure measurement is not being used, disconnection is detected to only a limited extent when accessories (tube extension, HME/F etc.) are connected.
- ⇒ Check alarm settings and adjust to the therapy if required.

- ! WARNING**
Risk of injury if patient valve is covered!
If the patient valve is covered, exhaled air can no longer be routed away.
- ⇒ Keep patient valve clear.

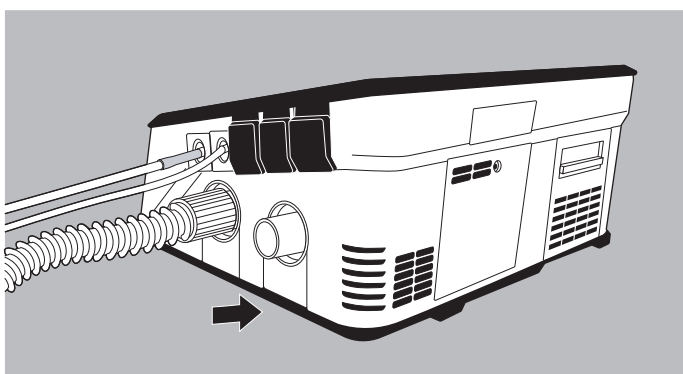

1. Push the inspiration tube onto the device outlet port.
2. Push the pressure measuring tube (blue marking) onto the inlet for the pressure measuring tube P_{tr} .

- i** It is possible to use the device without a pressure measuring tube. Use without a pressure measuring tube must be selected during the circuit test.
3. Push the valve control tube onto the inlet port for the valve control tube \downarrow .
 4. Connect the patient interface (e.g. breathing mask) to the circuit.

4.2.4 Connecting circuit for mouthpiece ventilation

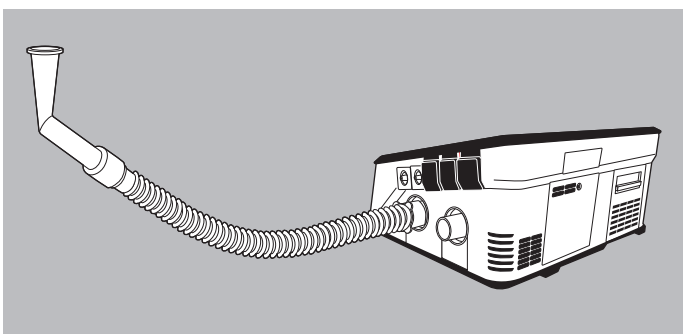

1. Push the free end of the leakage circuit onto the device outlet. It is likewise possible to use a single circuit with valve or a double circuit.
2. Connect mouthpiece to the tube (see instructions for use for the patient/ventilator interface).

4.2.5 Connecting the circuit for HFT mode

- i** As an alternative to the leakage circuit, it is also possible to use a single circuit with valve or a double circuit.

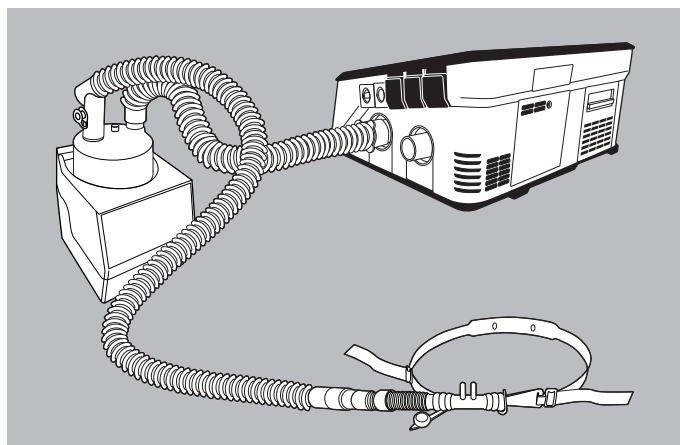

1. Push inspiration tube (short tube) onto the device outlet.
2. Push the other end of the inspiration tube (short tube) onto the inlet of the humidifier chamber marked **In**.
3. Push the second inspiration tube (long tube) onto the outlet port of the humidifier chamber marked **Out**.
4. Connect the HFT nasal cannula to the inspiration tube (long tube).
5. If necessary, connect the tube heater and temperature probe to the inspiration tube (long tube) (see instructions for use for the external respiratory air humidifier).





4.3 Before first use

Before using the device for the first time, you must set the date and time on it if your specialist dealer has not already done so.

- i** The language can only be set by a specialist user (expert).

The device can be supplied with a charged internal battery. To charge the internal battery fully, leave the device connected to the power supply for at least 1 hour.

4.4 Switch device on and off / Start and end therapy

Action	Requirement	Key	Operating state achieved
Switch on device ¹⁾	Device is connected (See Setting up and connecting device [▶ 11]).	Briefly press on/off key  on the device.	On, therapy not in progress
Switch off device	-	Press and hold on/off key  on the device.	Off
Starting therapy	Device is switched on.	Briefly press the On/off key  on the device <i>or</i> Press Start therapy in the display.	On, therapy in progress
End therapy	-	Press and hold on/off key  on the device. <i>or</i> Press and hold End therapy in the display. Confirm end of therapy in the display (OK key).	On, therapy not in progress

¹⁾ The device performs function tests when it is switched on (approx. 20 seconds). It can only be operated after the function tests are complete.

4.5 Circuit test

The circuit test checks the resistance, compliance, and leaktightness of the circuit.

Perform a circuit test in the following scenarios:

- In the function check (See [Function check](#) [▶ 18])
- Following a change of patient
- Following change or replacement of accessories and spare parts
- As required

Perform circuit test

Requirement

- ✓ Patient type and patient interface have been set by the specialist user (expert).
1. Select the **System > Circuit test** menu.
The therapy programs are listed in the **Overview of circuit test** area. The green checkmark indicates the therapy program selected.
 2. If required, use the (See [Display](#) [▶ 8]) program key to select the therapy program for which a circuit test is to be performed.
 3. Press the **Start** key.
 4. If using a leakage circuit: Select the configuration of the circuit (with exhalation system/without exhalation system).
 5. If using a single circuit with valve or a double circuit: Select the configuration of the circuit (with proximal pressure measurement/without proximal pressure measurement).
 6. Follow instructions in the display.
 7. If the circuit test is successful, press the **Finish** key.

8. If the circuit test fails, follow the instructions on the display to eliminate the fault.

4.6 Performing SpO₂ measurement

You can measure oxygen saturation (SpO₂) and pulse rate with the SpO₂ sensor. The measured values (SpO₂ and pulse rate) are shown on the home display and saved in the device. The measured values can be exported and read in the prismaTS software (See [System](#) [▶ 16]).

Alarms can be set to monitor the measurements (SpO₂ and pulse rate) (See [set alarms](#) [▶ 21]).

Following a power outage lasting more than 30 seconds, all settings and data are retained. The latest settings for the SpO₂ sensor are restored.

Requirement

- ✓ The SpO₂ sensor has been calibrated to display functional oxygen saturation.

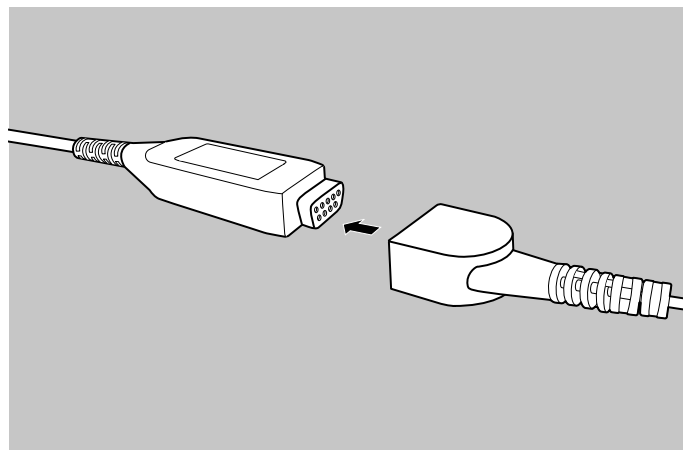

1. Connect the SpO₂/Xpod[®] cable to the SpO₂ sensor.

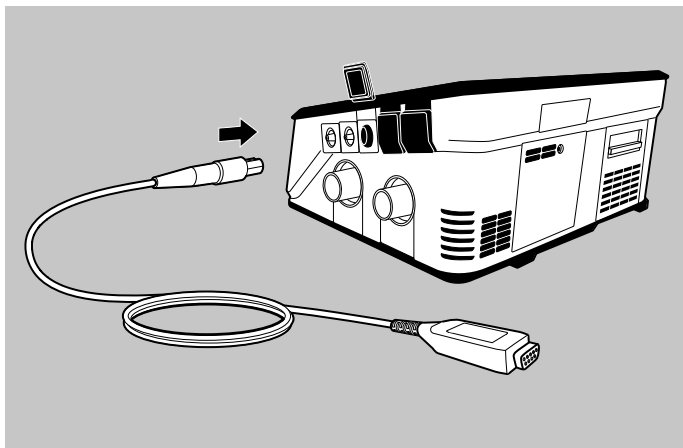

2. Connect the SpO₂/Xpod® cable to the device.

⚠ CAUTION

Risk of injury due to pressure points!

- ⇒ Avoid excessive pressure caused by the SpO₂ sensor.
- ⇒ Check the fit of the SpO₂ sensor every 6 to 8 hours to ensure that the sensor is in the correct position and that the skin is undamaged. The patient's sensitivity may vary depending on medical state or skin condition.

3. Place the SpO₂ sensor on the patient (e.g., on the finger).

4.7 Calibrating the FiO₂ cell

You can use the optional FiO₂ cell to perform continuous FiO₂ measurement. You must activate the FiO₂ cell before use and calibrate it every 6 weeks.

Calibration can take place during ventilation. You cannot perform FiO₂ measurement during the calibration process (duration approx. 5 minutes).

1. Open the **System > FiO₂ cell > Calibrate** menu.
2. Shut off the oxygen supply.
3. Wait approx. 30 seconds.
4. Press the **OK** key to start calibration.
5. If calibration is successful, press the **Finish** key. If calibration is not successful, follow the instructions in the display and eliminate the faults.
6. Resume the supply of oxygen.

i The FiO₂ cell is continuously emptied as a result of contact with oxygen. Once the FiO₂ cell is almost empty, a message appears to say that the FiO₂ cell needs replacing. The FiO₂ cell is replaced by an authorized specialist dealer or by a specialist user (expert).

4.8 Pairing device with LUISA app

The LUISA app (option) is an app on a mobile terminal which you can use to read off the patient's therapy data.

1. Activate the Bluetooth function in the **System > Device settings > Connectivity** menu.
2. In the **Device list** menu, select the **Add new device** entry.
3. Download the LUISA app onto a mobile terminal and follow the instructions in the LUISA app.

The pairing with the ventilator is saved in the LUISA App and does not need to be repeated. The saved pairing with the ventilator can be deleted in the LUISA App.



4.9 Contaminated components

After the device has been used, the following components in the gas path may be contaminated:

- LMT 31494 Device outlet port
- LMT 31503 FiO₂ cell
- LMT 31497 FiO₂ cell sealing
- LMT 31496 Flow sensor
- LMT 31505 Nonreturn valve, complete
- LMT 31530 Sound insulation case, pressure side
- LMT 31490 Blower
- LMT 31525 Sound insulation case, intake side
- LMT 31446 Center part of housing LM150TD
- WM 29389 Fine filter
- LMT 31487 Filter for cooling fan
- LMT 31422 Filter holder

5 Settings in the menu

5.1 Navigating in the menu

Action	Function
Press function key	Function keys have a gray background and the function is displayed on the key in text or as a symbol. Symbols on a black background are not function keys, but serve to provide information about device status (See Symbols in display [▶ 8]).
Scroll in list	Navigate up or down.
Press "Value"	Open scale of values to set therapy parameters.
Move range of values up or down	Decrease or increase value.
	Confirm value.
	Discard selection.
	Back to home display.

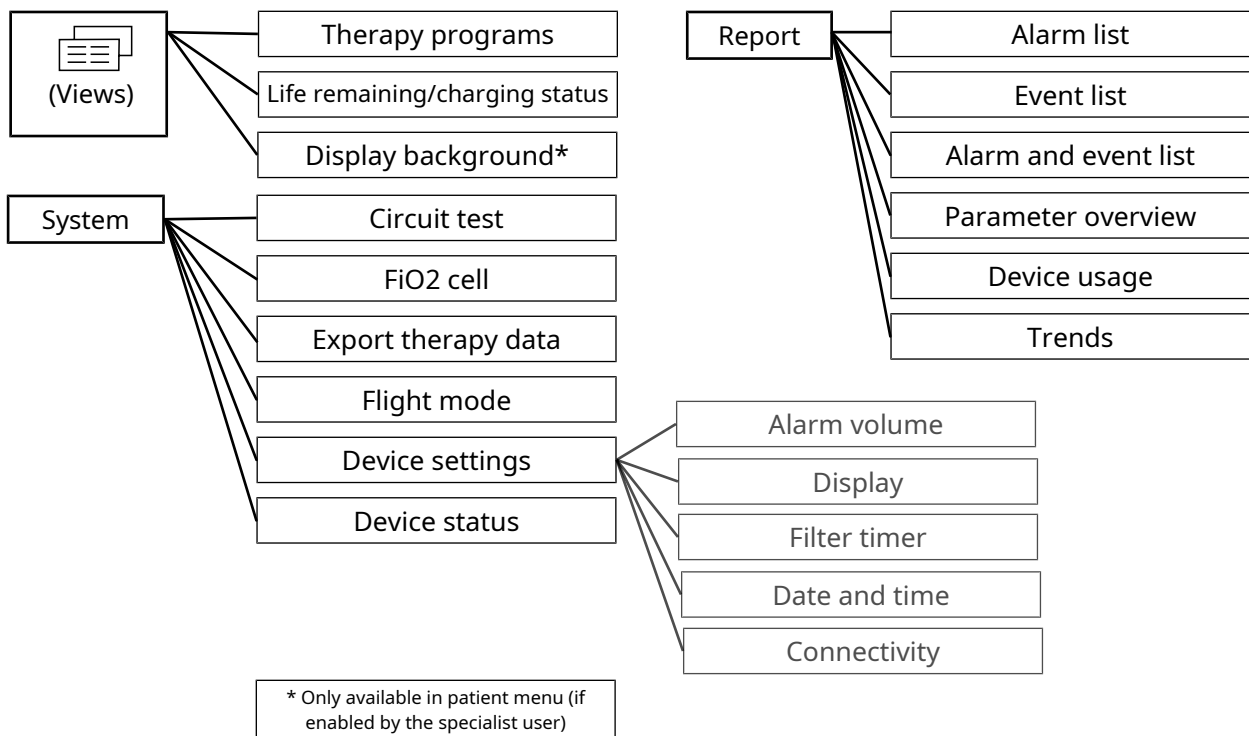

5.2 Menu structure



5.2.1 Views menu

The Views menu shows various views. To switch to the next view in each case, press the Views key again.

 The horizontal lines on the Views key are the number of available views.

	Parameters and set values for the therapy programs
	Operating status On, therapy in progress : Remaining device life if being supplied by battery
	Operating status On, therapy not in progress : Charging state of the internal battery in percent assuming a power supply



View is only available in the patient menu if a display background has been selected in the device settings of the expert menu.

5.2.2 Report menu

Alarm list	Lists the alarms which have occurred.
Event list	Lists the events that have occurred.
Alarm and event list	Lists the alarms and events which have occurred in chronological order.
Device usage	Lists the usage time of the device and the duration of therapy for the patient.
Parameter overview	Lists the parameters set for the therapy programs.
Trends	Displays therapy data for the past 30 days in graphical form.

5.2.3 System menu

Circuit test	Perform a circuit test (See Performing a circuit test [▶ 13]).
FiO ₂ cell	Activate, deactivate and calibrate FiO ₂ cell (See Calibrating FiO₂ cell [▶ 14]).
Export therapy data	Export detailed data set (therapy data, statistical data, log data etc.) to a USB-C flash drive. A USB-C flash drive must be connected.
Flight mode	If flight mode is activated, wireless communication (e.g. wireless LAN, Bluetooth) is impossible.
Device settings	Set the device (see table below).
Device status	Information about the device (name, type, serial number of device and components, firmware version) and about the internal battery.

5.2.3.1 Device settings

Alarm volume	Set alarm volume.
Display	Set brightness, orientation, and display background.
Filter timer	Activate and reset the filter change reminder function.
Date and time	Set current date and time.
Connectivity	Activate and deactivate Bluetooth.

6 Reprocessing and maintenance

6.1 Hygiene treatment

- ! WARNING**
Risk of infection if device and accessories are reused!
Infections can be transmitted and the device contaminated on change of patient.
- ⇒ Use the breathing system filter.
 - ⇒ Do not reuse disposables.
 - ⇒ Do not reprocess disposables.

6.1.1 General information

- To prevent foreign bodies being taken in, ensure that new filters are inserted following reprocessing, maintenance or servicing.
- Following reprocessing by the specialist dealer, the device is suitable for a change of patient.

Ensure that cleaning is completed with care and that no detergent residues are left behind. Rinse all parts with clean water.

6.1.2 Intervals

Interval	Action
Weekly	Clean device (See Cleaning device [▶ 17]).
Monthly	Clean coarse dust filter (See Cleaning coarse dust filter [▶ 17]).
	Replace fine filter (See Replacing fine filter [▶ 17]).
	Clean filter for cooling air fan (See Cleaning filter for cooling air fan [▶ 18]).
Every 6 months	Replace coarse dust filter

6.1.3 Reprocessing device

- ! WARNING**
Risk of injury from electric shock!
Ingress of liquids may lead to a short-circuit, injure the user, and damage the device.
- ⇒ Disconnect the device from the power supply before reprocessing.
 - ⇒ Do not immerse the device and components in liquids.
 - ⇒ Do not pour liquids over the device and components.

- ! WARNING**
Risk of injury from use of ozone!
Ozone cleaning devices may damage the materials and thus put the patient at risk.
- ⇒ Clean ventilator, accessories, and patient interface only in accordance with the associated instructions for use.
 - ⇒ Do not use ozone cleaning devices.

Cleaning device

1. Disconnect accessories and cables from the device.
2. Wipe over the housing including the device outlet port, the power cord, and the display with a damp cloth. Use a lint-free cloth slightly moistened with water and/or a mild detergent.
3. Clean or replace the mask, circuit, coarse dust filter, fine filter, filter for the cooling air fan, and the breathing system filter. Follow the manufacturer's instructions for use for the accessory.
4. Perform a function check (See [Function check](#) [▶ 18]).

Clean coarse dust filter (gray filter)

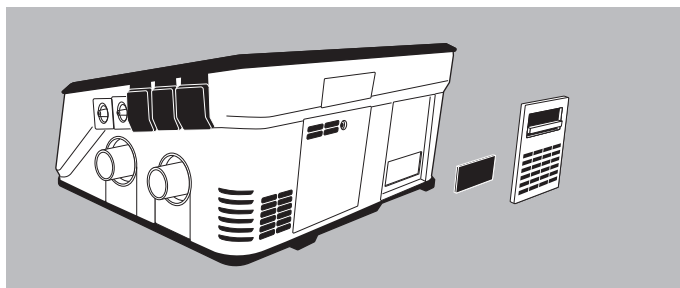

1. Open filter compartment.
2. Remove coarse dust filter.
3. Wash coarse dust filter under running water.
4. Allow coarse dust filter to air-dry.
5. Insert coarse dust filter.
6. Close filter compartment.

Replace fine filter (white filter)

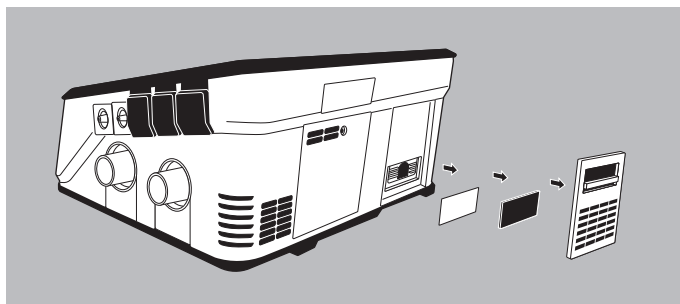

1. Open filter compartment.
2. Remove gray coarse dust filter.
3. Remove and replace white fine filter.

4. Insert coarse dust filter.
5. Close filter compartment.

Clean filter for cooling air fan

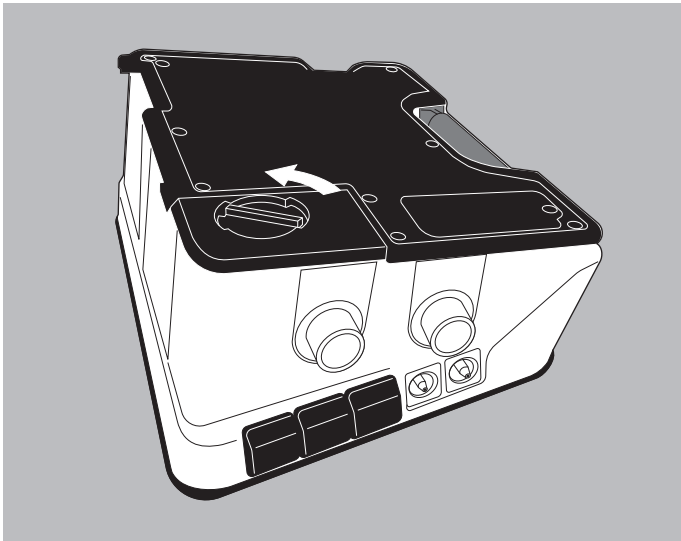

1. To open the exhalation module compartment on the rear of the device, turn the latch counterclockwise to the symbol.
2. Remove cover.

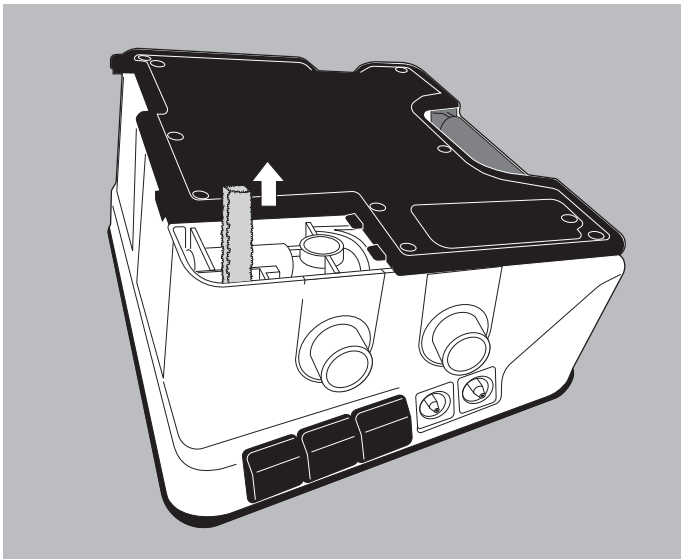

3. Remove filter.
4. Wash filter under running water.
5. Allow filter to air-dry.
6. Insert filter.
7. Close exhalation module compartment.

6.2 Function check

Carry out a function check before using the device for the first time, after every hygiene treatment, and after every repair, but at least every 6 months.

1. Check device for external damage.

2. Check connectors, cables, and accessories for external damage. Consult associated instructions for use.
3. Check that accessories are connected to the device correctly.
4. Connect the device to the power supply (See [Setting up and connecting device](#) [▶ 11]).
5. Switch on the device (See [Switching device on and off / Starting and ending therapy](#) [▶ 13]). The device automatically performs a few function tests on the sensor system. If fully functional, the device will show the home display.
6. Check the functionality of the batteries:
 - Disconnect the device from the power supply. The first external battery (if present) takes over energy supply (watch what is shown in display).
 - Disconnect the first external battery from the device. The second external battery (if present) takes over energy supply.
 - Disconnect the second external battery from the device. The internal battery takes over energy supply.
7. Check battery capacity (See [Battery life and battery capacity](#) [▶ 9]). If battery capacity is low, connect the device to the power supply.
8. If one of the items is not OK: Do not use device or accessory and contact your specialist dealer.
9. Perform a circuit test (See [Performing a circuit test](#) [▶ 13]). If the circuit test fails, follow the instructions on the display and eliminate the faults.
10. Seal the end of the circuit and start therapy. A brief acoustic alarm must be audible on starting. The device automatically performs a few function tests. The alarm acknowledgement key lights up yellow and red.
11. Compare the therapy pressure displayed with the prescribed pressure. If the pressure deviation is > 1 hPa: Do not use device or accessory and contact your specialist dealer.
12. If a FiO₂ cell is in use: Calibrate FiO₂ cell (See [Calibrating FiO₂ cell](#) [▶ 14]).
13. When using an SpO₂ sensor:
 - Check whether the SpO₂ sensor determines measured values and shows them in the display (SpO₂, pulse rate).
 - Check whether the SpO₂ symbol in the status line lights up green.

Do not use a functional tester to assess the accuracy of an SpO₂ sensor or a pulse oximeter.

14. If required: Check alarms (See [Checking alarms](#) [▶ 19]).

6.2.1 Checking alarms

Physiological alarms

Alarm	ID no.	Requirement	Test
Leakage high	459	On a single circuit with valve: Alarm limit is set to a value < 150 l/min. With leakage circuit: Alarm limit is set to a value < 60 l/min. On a double circuit, 15 mm/22 mm: Alarm limit is set to a value < 60 l/min.	Leave the inspiration tube on the patient connection port open. Start therapy. Wait at least 30 seconds, more alarms may occur during this period.
Pressure low	457	Alarm limit is set to a value \geq 6 hPa.	Leave the inspiration tube on the patient connection port open. Start therapy.
Tidal volume low	450	Double circuit: Alarm limit is set.	Start therapy. Take expiration tube off device inlet port. Wait 3 breaths.
FiO ₂ low	494	FiO ₂ cell is fitted and activated. Alarm limit is set. No external oxygen supply connected.	Start therapy.

Technical alarms

Alarm	ID no.	Requirement	Test
Exhalation blocked	757	Single circuit with valve is connected. or Double circuit is connected.	Connect test lung. Start therapy. On a single circuit with valve: Seal patient valve. On a double circuit: Take the expiration tube off the device inlet and seal the expiration tube.
Battery capacity low	551	Device is not connected to the power supply.	Start therapy until the internal battery has 15 minutes' life remaining before it discharges completely.
Battery capacity critical	550	Device is not connected to the power supply.	Start therapy until the internal battery has 5 minutes' life remaining before it discharges completely.
Supply via internal battery	581	None	Disconnect power cord from device. Disconnect the external batteries from the device.

6.3 Servicing

The device is designed for the following service life: 10 years. If the device is used beyond this period, it needs checking by the manufacturer or by an authorized specialist dealer.

For Germany: In accordance with §11 Medizinprodukte-Betreiberverordnung [German law governing health institutions using medical devices], the device must be subjected to a Technical Safety Check [Sicherheitstechnische Kontrolle (STK)] every 2 years. Country-specific requirements apply to all other countries.

Expected useful life	10 years
Maintenance interval for batteries	4 years or 500 charge cycles
Maintenance interval for membrane of nonreturn valve	4 years
Maintenance interval for blower	35,000 h life

6.4 Disposal

Do not dispose of the product or any batteries present with domestic waste. To dispose of properly, contact a licensed, certified electronic waste disposal merchant. This address is available from your Environment Officer or from your local authority. The device packaging (cardboard and inserts) can be disposed of in paper recycling facilities.

7 Alarms

7.1 General information

The device uses acoustic and visual alarms to make you aware of an acute or imminent risk requiring your attention and your intervention.

Alarm priorities





Alarms are divided into the three priorities low , medium , and high .

If several alarms are triggered simultaneously, the highest-priority alarm is shown first. The lower-priority alarm is retained and is displayed once the higher-priority alarm has been rectified.

Alarm data and alarm settings

Alarm data are saved in the alarm list. The log is retained when the alarm system or the device is switched off. The start and end of ventilation is recorded. The log can store 1,000 alarms. Once this capacity limit has been reached, the oldest alarm is deleted and the new alarm is saved.

7.2 Reacting to an alarm

1. Secure the patient's ventilation and oxygen supply.
2. To mute an alarm temporarily, briefly press alarm acknowledgement key .
or
To mute all alarms for 2 minutes, press and hold alarm acknowledgement key .
The fault continues to be displayed in the status line and the alarm acknowledgement key flashes until the fault has been rectified.
To stop muting the alarms, briefly press alarm acknowledgement key  again.
3. Take action to rectify the alarm situation (See [Physiological alarms](#) ▶ 21) and (See [Technical alarms](#) ▶ 23).
4. To acknowledge an alarm once the fault has been rectified, briefly press alarm acknowledgement key .

7.3 set alarms

All physiological alarms are deactivated on delivery or when the device is reset to factory settings. The healthcare professional activates the physiological alarms and makes the alarm settings suitable for the patient. Various alarms can be set depending on the therapy mode selected.

Performance









1. In the expert menu, open the **Alarms** menu.
2. Select the desired alarm.

3. Set and confirm the desired value.
In doing so, note the following conditions:
 - Set sensible alarm limits.
 - Set identical alarms in different clinical environments.
 - Check before use whether all alarm settings are suitable for the patient.
4. Set alarm volume in the **System > Device settings > Alarm volume** menu.
Ensure that the alarm sound is easy to hear.

7.4 Physiological alarms

Physiological alarms relate to ventilation of the patient.

If set parameter ranges are exceeded or undershot, the device issues an alarm.

Display	Code	Cause	Action
Apnea 	458	No spontaneous breathing within set time.	Check therapy and alarm settings for plausibility and suitability for the patient.
Pressure high 	456	Set therapy pressure exceeded.	Check therapy and alarm settings for plausibility and suitability for the patient.
Pressure low 	457	Filter dirty.	Clean or replace the filter.
		Patient/ventilator interface leaking or defective.	Check patient interface is OK and fitted correctly. If necessary, Replace patient/ventilator interface.
		Set therapy pressure undershot.	Check therapy and alarm settings.
Rate high 	453	Set respiratory frequency exceeded.	Check therapy and alarm settings for plausibility and suitability for the patient.
Rate low 	452	Set respiratory frequency undershot.	Check therapy and alarm settings for plausibility and suitability for the patient.
Leakage high 	459	Leak	Check circuit and patient interface are OK and fitted correctly.
Minute volume high 	455	Set minute volume exceeded.	Check therapy and alarm settings.
Minute volume low 	454	Set minute volume undershot.	Check therapy and alarm settings for plausibility and suitability for the patient.

Display	Code	Cause	Action
Pulse high ▲▲	493	Set pulse rate exceeded.	Check therapy and alarm settings for plausibility and suitability for the patient.
Pulse low ▲▲▲	492	Set pulse rate undershot.	Check therapy and alarm settings for plausibility and suitability for the patient.
SpO2 high ▲▲	491	Set oxygen saturation exceeded.	Check therapy and alarm settings for plausibility and suitability for the patient.
SpO2 low ▲▲▲	490	Patient/ventilator interface leaking or defective.	Check patient interface is OK and fitted correctly. If necessary, Replace patient/ventilator interface.
		Quantity of oxygen supplied too low.	Adapt therapy.
		Set oxygen saturation undershot.	Check therapy and alarm settings.
Tidal volume low ▲▲▲	450	Unintentional leakage in circuit or pneumatic unit (FiO ₂ cell and expiration module) for unintentional leakage and that they are fitted correctly. Perform a circuit test. If necessary, Replace defective part.	Check circuit and pneumatic unit (FiO ₂ cell and expiration module) for unintentional leakage and that they are fitted correctly. Perform a circuit test. If necessary, Replace defective part.
		Filter dirty.	Clean or replace the filter.
		Patient/ventilator interface leaking or defective.	Check patient interface is OK and fitted correctly. If necessary, Replace patient/ventilator interface.
		Set tidal volume undershot. Patient breathing as well.	Check therapy and alarm settings for plausibility and suitability for the patient.
		Minimum volume is not reached within the specified time in MPVv mode.	Check therapy and alarm settings for plausibility and suitability for the patient.
Tidal volume high ▲▲▲	451	Set tidal volume exceeded. Patient breathing as well.	Check therapy and alarm settings for plausibility and suitability for the patient.
Tidal volume on exp. low ▲▲▲	470	Minimum exhalation volume undershot.	Check therapy and alarm settings for plausibility and suitability for the patient.
Tidal volume on exp. high ▲▲▲	471	Maximum exhalation volume exceeded.	Check therapy and alarm settings for plausibility and suitability for the patient.



Display	Code	Cause	Action
Minute volume on exp. low ▲▲▲	472	Minimum expiratory minute volume undershot.	Check therapy and alarm settings for plausibility and suitability for the patient.
Minute volume on exp. high ▲▲	473	Maximum expiratory minute volume exceeded.	Check therapy and alarm settings for plausibility and suitability for the patient.
Minute volume on insp. low ▲▲▲	474	Minimum inspiratory tidal volume undershot.	Check therapy and alarm settings for plausibility and suitability for the patient.
Tidal volume on insp. high ▲▲▲	475	Maximum inspiratory tidal volume exceeded.	Check therapy and alarm settings for plausibility and suitability for the patient.
Minute volume on insp. low ▲▲▲	476	Minimum inspiratory minute volume undershot.	Check therapy and alarm settings for plausibility and suitability for the patient.
Minute volume on insp. high ▲▲	477	Maximum inspiratory minute volume exceeded.	Check therapy and alarm settings for plausibility and suitability for the patient.
PEEP high ▲▲▲	469	End-expiratory pressure high.	Check therapy and alarm settings for plausibility and suitability for the patient.
FiO ₂ low ▲▲▲	494	Quantity of oxygen supplied too low.	Check whether the prescribed oxygen flow is set correctly at the oxygen source.
		Leakage	Check circuit, patient interface, and oxygen supply for unintentional leakage and that they are fitted correctly.
		FiO ₂ cell calibrated incorrectly.	Calibrate FiO ₂ cell.
FiO ₂ high ▲▲▲	495	Quantity of oxygen supplied too high.	Check whether the prescribed oxygen flow is set correctly at the oxygen source.
		FiO ₂ cell calibrated incorrectly.	Calibrate FiO ₂ cell.
Disconnection patient ▲▲▲	464	Patient/ventilator interface leaking or defective.	Check patient interface is OK and fitted correctly. If necessary, Replace patient/ventilator interface.

7.5 Technical alarms

Technical alarms relate to configuration of the device. The technical alarms are active and cannot be configured.

Temperature of battery E1/2 high △△△	547 548	External battery too warm.	Battery will switch off due to temperature. Operate the device at the following temperature: +5 °C to +40 °C. Connect the device to the power supply.	Life of battery E1/2 at an end △△	562 563	Service life of external battery at an end.	Replace battery.
Error internal battery △△△	549	Internal battery defective.	Contact your specialist dealer. Have internal battery replaced.	Battery E1/2 over-heated △△△	564 565	External battery 1 overheated.	Battery has switched off due to temperature. Operate the device at the following temperature: +5 °C to +40 °C.
Battery capacity critical △△△	550	Battery discharged (remaining battery life: 5 minutes)	Connect the device to the power supply.	Unable to charge battery E1/2 △△	566 567	External battery 1 defective.	Contact your specialist dealer.
Battery capacity low △△	551	Battery discharged (remaining battery life: 15 minutes)	Connect the device to the power supply.	Temperature of battery E1/2 high △△	568 569	External battery 1 too warm.	Operate the device at the following temperature: +5 °C to +40 °C.
No internal battery △△△	553	No internal battery.	Contact your specialist dealer. Have internal battery inserted.	Temperature of battery E1/2 low △△	570 571	External battery 1 too cold.	Operate the device at the following temperature: +5 °C to +40 °C.
Temperature of internal battery too high △△△	555	Internal battery too warm.	Battery will switch off due to temperature. Operate the device at the following temperature: +5 °C to +40 °C. Connect the device to the power supply.	Error internal battery communication △△	572	Internal battery defective. Device defective.	Contact your specialist dealer.
Internal battery over-heated △△△	556	Internal battery overheated.	Battery has switched off due to temperature. Operate the device at the following temperature: +5 °C to +40 °C.	Error battery E1/2 communication △△	573 574	External battery defective. Device defective.	Contact your specialist dealer.
Unable to charge internal battery △△	558	Internal battery defective.	Contact your specialist dealer. Have internal battery replaced.	Error battery E1/2 △△△	575 576	External battery defective.	Contact your specialist dealer.
Temperature of internal battery high △△	559	Internal battery too warm.	Operate the device at the following temperature: +5 °C to +40 °C.	Error internal battery temperature △△△	577	Ambient temperature too high.	Operate the device at the following temperature: +5 °C to +40 °C.
Temperature of internal battery low △△	560	Internal battery too cold.	Operate the device at the following temperature: +5 °C to +40 °C.	Error battery E1/2 temperature △△△	578 579	Ambient temperature too high.	Operate the device at the following temperature: +5 °C to +40 °C.
Life of internal battery at an end △△	561	Service life of internal battery at an end.	Contact your specialist dealer. Have internal battery replaced.	Energy supply outage △△△	580	Power supply failed.	Use alternative ventilation option. Check connection of device to power supply.
				Supply via internal battery △	581	Power supply failed.	Check connection of device to power supply.
						External battery and power supply not connected.	Note remaining battery life. Connect device to power supply.

Error FiO ₂ cell △△	770	FiO ₂ cell defective.	Contact your specialist dealer. Have FiO ₂ cell replaced.	No exhalation system △△△	753	No exhalation system.	Connect exhalation system. Check circuit and patient interface are OK and fitted correctly.
No FiO ₂ cell △△	771	No FiO ₂ cell.	Contact your specialist dealer. Have FiO ₂ cell inserted.	Pressure permanently low △△△	755	Mask leakage too high.	Check mask position.
FiO ₂ cell empty △△	773	FiO ₂ cell empty.	Contact your specialist dealer. Have FiO ₂ cell replaced.	Tidal volume permanently low △△△	756	Settings implausible (alarm limit for tidal volume undershot).	Check therapy and alarm settings.
SpO ₂ signal weak △△	790 792	SpO ₂ sensor not connected to the finger.	Check fit of SpO ₂ sensor. If alarm persists: Contact your specialist dealer.	Exhalation blocked △△△	757	Exhaled air outlet blocked.	Check exhalation system and expiration module.
SpO ₂ signal weak △		Signal of SpO ₂ sensor impaired by nail varnish or contamination.	Remove nail varnish. Clean finger.	Therapy pressure constant △△△	758	Respiratory frequency or set pressure difference too low.	Check therapy and alarm settings.
SpO ₂ sensor removed △△	791	No SpO ₂ sensor.	Connect SpO ₂ sensor. If alarm persists: Replace SpO ₂ sensor.	Intake area blocked △△	759	Intake area blocked.	Keep intake area free.
Cable for SpO ₂ sensor removed △△	793	Cable for SpO ₂ sensor removed.	Connect cable for SpO ₂ sensor.	Pressure measuring and valve control tubes switched △△△	760	Valve control tube and pressure measuring tube switched.	Check circuit fitted correctly.
Service necessary	Various	Technical fault which can only be eliminated by a specialist dealer.	Contact your specialist dealer. Have device repaired.	Valve control tube kinked.		Check valve control tube. If necessary, Replace valve control tube.	
Display error △△△	173	Display failed.	Press on/off key to restart the device.	Blower temperature high △△△	789	Blower temperature too high. Cooling air filter blocked.	Operate the device at the following temperature: +5 °C to +40 °C.
Temperature of ambient air high △△△	262	Ambient temperature too high.	Operate the device at the following temperature: +5 °C to +40 °C.	Therapy ended △△△	794	Therapy ended.	Start therapy.
Temperature of main board high △△△	263	Ambient temperature too high.	Operate the device at the following temperature: +5 °C to +40 °C.	Circuit defective △△△	795	Single circuit with valve set in menu but double circuit connected.	Change circuit or select connected circuit in the menu.
Computer module temperature high △△△	264	Ambient temperature too high.	Operate the device at the following temperature: +5 °C to +40 °C.	Leakage circuit set in menu, but single circuit with valve connected.		Circuit defective.	
Check flow setting and/or accessories △	364	Set flow not reached.	Check therapy settings. Check accessory OK and correctly fitted.	Rebreathing △△△	796	Valve dirty. Valve does not open in expiration.	Check circuit OK and fitted correctly. If necessary, replace circuit.
						Patient's re-inhalation volume excessive at high frequency.	

Blower over-heated 	799	Blower over-heated.	Therapy will end. Allow device to cool down.
Maximum device pressure exceeded 	811	Resistance on inspiration too high.	Reduce resistance and restart device. If the physiological alarm persists, contact your specialist dealer.
Maximum device pressure reached 	825	Resistance on inspiration too high.	Reduce resistance and restart device. If the physiological alarm persists, contact your specialist dealer.

7.6 Nurse call and remote alarm

For support in monitoring patient and device (especially in the case of life-support ventilation), the device has a remote alarm connection. All alarms are passed on to this connection.

In a clinical setting, the device can be connected to the hospital's internal alarm system via the remote alarm connection.

8 Troubleshooting

Fault	Cause	Action
No running noise, nothing in the display.	No power supply.	Check connection of device to power supply. Check socket.
Device not reaching set therapy pressure.	Coarse dust filter soiled.	Clean coarse dust filter. If necessary, Replace filter (See Reprocessing [▶ 17]).
	Mask leaking.	Adjust mask so that the mask does not leak (see instructions for use for the mask). If necessary, Replace defective mask.
	Breathing circuit leaking.	Check circuit and eliminate leaks. If necessary, replace circuit.
	Device defective.	Contact your specialist dealer.
Dark display does not react to display being touched. Display remains dark.	Device switched off.	Switch on device (See Switching device on and off [▶ 13]).
Device does not respond to display input.	Electronics in device have failed.	Restart device (press and hold on/off key  for 30 s).

9 Technical data

9.1 Ambient conditions

Temperature range, operation	+5 °C to +40 °C
Temperature range, storage	-25 °C to +70 °C
Humidity for operation, transport, and storage	Relative humidity 15 % to 90 %, no condensation > 35° C to 70° C at a water vapor pressure up to 50 hPa
Air pressure range	700 hPa to 1100 hPa, corresponds to an altitude of 3000 m above mean sea level

9.2 Physical specifications and classifications

Dimensions (W x H x D)	30 cm x 13 cm x 21 cm
Weight	3.8 kg
Classification to IEC 60601-1: Application part	Patient interface (e.g. breathing mask, endotracheal tube, tracheal cannula), circuit, breathing system filter, SpO ₂ sensor
Classification to ISO 5356-1: Diameter of device outlet connection	Standard 22 mm tapered connector
Classification to MDR (EU) 2017/745: product class	IIb
Classification to IEC 60601-1-11: Protection class	Class of protection against electric shock: Class II Degree of protection against electric shock: Type BF
Protection against ingress of solids and water	IP22: Protection against finger-sized objects and against drips with an inclination of up to 15 degrees
Classification to IEC 60601-1: Operating mode	Continuous duty
Standards applied	EN ISO 80601-2-72: Particular requirements for the basic safety and essential performance of home ventilation devices for patients dependent on the device

9.3 Materials

Housing	Fire-retardant technical thermoplastics and silicones, stainless steel
Fine filter	Mix of synthetic fibers bonded with PP (polypropylene) fleece
Coarse dust filter	Polyester foam
Circuit	Polyethylene

9.4 Electronics and physical interfaces

Maximum electrical power consumption	48 VDC / 2.7 A 24 VDC / 5.4 A 12 VDC / 7.0 A
System interface	3 VDC/0.2 A
USB-C interface	5 V/1.1 A
Maximum power output (no power input)	
Power consumption, operating status On (therapy not in progress)	230 VAC / 0.07 A 48 VDC / 0.30 A 24 VDC / 0.61 A 12 VDC / 1.21 A ^{1) 2)}
Power consumption, operating status On (therapy in progress)	230 VAC / 0.18 A 48 VDC / 0.81 A 24 VDC / 1.61 A 12 VDC / 2.86 A ¹⁾
Power consumption, nurse call	Maximum 60 VDC/1 A
Power supply unit: Input voltage/maximum current	100-240 VAC / 2.0 A - 1.0 A ³⁾
Power supply unit: Input frequency	50-60 Hz
Power supply unit: Output voltage/maximum current	48 VDC/2.7 A

¹⁾ Without battery charging, screen brightness 90 %

²⁾ With the following settings: Mode: T, Patient: Adult, leakage circuit 15 mm, IPAP: 40 hPa, EPAP: 4 hPa, F: 26.5/min, Ti: 1.1 s, Pressure rise: Level 1, Pressure reduction: Level 1, Test lung, additional accessories: Breathing system filter, WilaSilent exhalation system

³⁾ Tolerance: -20 % + 10 %

9.5 Therapy

All physiological flow and volume values are displayed in BTPS (target volume, tidal volume, minute volume).

All other flow and volume values are displayed in STPD.

Most disadvantageous circuit

Single circuit with valve (measured volume < 50 ml)	LMT 31383 Breathing system filter: WM 27591
Single circuit with valve (measured volume ≥ 50 ml)	LMT 31382, Breathing system filter: WM 27591
Leakage circuit	WM 29988, Breathing system filter: WM 27591
Double circuit	LMT 31577, Breathing system filter: WM 27591

Therapy pressure

IPAP (leakage circuit)	4 hPa - 50 hPa
IPAP (single circuit with valve, double circuit)	4 hPa - 60 hPa
IPAP accuracy	±(2 hPa + 4 % of the set value)
EPAP (leakage circuit)	4 hPa - 25 hPa
EPAP accuracy	±(2 hPa + 4 % of the set value)
PEEP (single circuit with valve, double circuit)	0 hPa - 25 hPa
PEEP accuracy	±(2 hPa + 4 % of the set value)
CPAP	4 hPa - 20 hPa
CPAP accuracy	±(2 hPa + 4 % of the set value)
Increment for therapy pressure	0.2 hPa
Speed of pressure rise adult	Level 1=100 hPa/s; Level 2=80 hPa/s; Level 3=50 hPa/s; Level 4=20 hPa/s
Speed of pressure increase child	Level 1=135 hPa/s; Level 2=100 hPa/s; Level 3=80 hPa/s; Level 4=50 hPa/s
Speed of pressure rise MPV mode	Level 1=60 hPa/s; Level 2=45 hPa/s; Level 3=30 hPa/s; Level 4=15 hPa/s
Speed of pressure reduction, adult	Level 1=-100 hPa/s; Level 2=-80 hPa/s; Level 3=-50 hPa/s; Level 4=-20 hPa/s
Speed of pressure reduction, pediatric	Level 1=135 hPa/s; Level 2=100 hPa/s; Level 3=80 hPa/s; Level 4=50 hPa/s
Maximum pressure in the event of a fault	< 90 hPa
Maximum applied flow at 20 hPa	> 220 l/min

Frequency

Adjustable back-up frequency, adult	2 - 60 bpm
Adjustable back-up frequency, pediatric	5 - 80 bpm
Increment for adjustable back-up frequency	0.5 bpm
Accuracy of adjustable back-up frequency	±0.5 bpm

Volume

Adjustable target volume, pediatric	30 ml to 400 ml
Adjustable target volume, adult	100 ml to 3000 ml
Increment of adjustable target volume from 30 ml to 100 ml	5 ml
Increment of adjustable target volume from 100 ml to 3000 ml	10 ml

Accuracy of the volume measured by the ventilator < 50 ml	$\pm (4 \text{ ml} + 20\% \text{ of current value})$, leakage circuit: $\pm(8 \text{ ml} + 20\% \text{ of current value})$
Accuracy of the volume measured by the ventilator $\geq 50 \text{ ml}$	$\pm (4 \text{ ml} + 15\% \text{ of current value})$, leakage circuit: $\pm(15 \text{ ml} + 20\% \text{ of current value})$
Measurable minute volume (average of the last 5 breaths)	0.1 l/min to 40 l/min

Times

Duration of inspiration, pediatric	0.2 s - 4 s in 0.05 s increments
Duration of inspiration (adult)	0.5 s - 4 s in 0.1 s increments
Duration of inspiration, auto	Ti timed only
Duration of inspiration, accuracy	$\pm 0.05 \text{ s}$
Ratio of inspiration to expiration (I:E)	1:59 to 2:1

Trigger

Trigger levels, inspiration	1 (high sensitivity) to 10 (low sensitivity)
Increment for trigger levels, inspiration	1
Trigger levels, expiration	95 % to 5 % of peak flow
Increment for trigger levels, expiration	5 %

The inspiratory trigger is triggered when inspiratory respiratory flow exceeds the trigger threshold. The expiratory trigger is triggered when inspiratory respiratory flow drops to the percentage value of maximum inspiratory respiratory flow.

Oxygen supply

Permitted oxygen flow	$\leq 30 \text{ l/min}$
Permitted pressure at oxygen inlet	$\leq 1000 \text{ hPa}$

9.6 Noise

Device (operation to ISO 80601-2-72)

	Sound pressure level	Sound power level
Tidal volume $\geq 500 \text{ ml}$	38.5 dB(A)	46.5dB(A)
Tidal volume $\geq 150 \text{ ml}$	37 dB(A)	45 dB(A)
Tidal volume $\geq 30 \text{ ml}$	41 dB(A)	49 dB(A)
Accuracy	$\pm 3 \text{ dB(A)}$	$\pm 3 \text{ dB(A)}$

Sound pressure level of alarm messages to IEC 60601-1-8 for all alarm conditions

	Volume level 1	Volume level 4
Low priority	69 dB(A)	88dB(A)
Medium priority	69 dB(A)	88 dB(A)
High priority	68 dB(A)	86 dB(A)
Accuracy	$\pm 4 \text{ dB(A)}$	$\pm 5 \text{ dB(A)}$

9.7 Batteries

Type	Li-ion
Nominal capacity	3200 mAh
Nominal voltage	29.3 V

Energy	93.7 Wh
Typical discharge cycles	500
Duration of complete battery charge	< 6 hours
Duration of 80 % battery charge	< 5 hours
Operating hours, internal battery	≥ 6 hours ¹⁾

¹⁾ With the following settings: Double circuit, Mode: PCV, f: 20 min, Ti: 1 s, PEEP: Off, Vt: 800 ml, Passive lung: Resistance R= 5 hPa /(l/s); Compliance C = 50 ml/hPa

9.8 Software

Devices of type LM150TD use the following open-source software: Kernel 4.19.132, Buildroot 2020.02.3

The software of this device contains code which is subject to the GPL. You can obtain the source code and the GPL on request.

9.9 Accessories

Classification, fine filter	Filter class E10, degree of separation of particles up to 1 µm > 99.5 %, degree of separation of particles up to 0.3 µm > 85 %, service life approx. 250 h
Dead space, breathing system filter	25 ml
Components for wireless communication: Frequency band	2.412 GHz to 2.4835 GHz

9.10 Accuracy of measuring devices used

Pressure	±0.75 % of measured value or ±0.1 hPa
Flow	±2 % of actual value
Volume	±3 % of actual value
Temperature	±0.3 °C
Time	±0.05 Hz / ±0.001 bpm
Sound pressure level	1.4 dB

9.11 SpO₂ sensor

Display range, SpO ₂ measurement	0 to 100%
Increment, SpO ₂ measurement	1 %
Display range, pulse rate measurement	0 to 255 bpm
Increment, pulse rate measurement	1 bpm
Accuracy	See instructions for use for 8000SX sensor
Data collection	Average over 4 beats
Data update	Every 1.5 s
Alarm preset: SpO ₂ measurement	85 %
Alarm preset: Pulse rate measurement	Off
Delay of alarm condition	1.5 s
Delay of alarm generation	15 s after alarm limit reached

The SpO₂ sensors listed in these instructions for use were validated and tested to EN ISO 80601-2-61.

10 Annex

10.1 Pneumatic diagram

10.1.1 Single circuit with valve

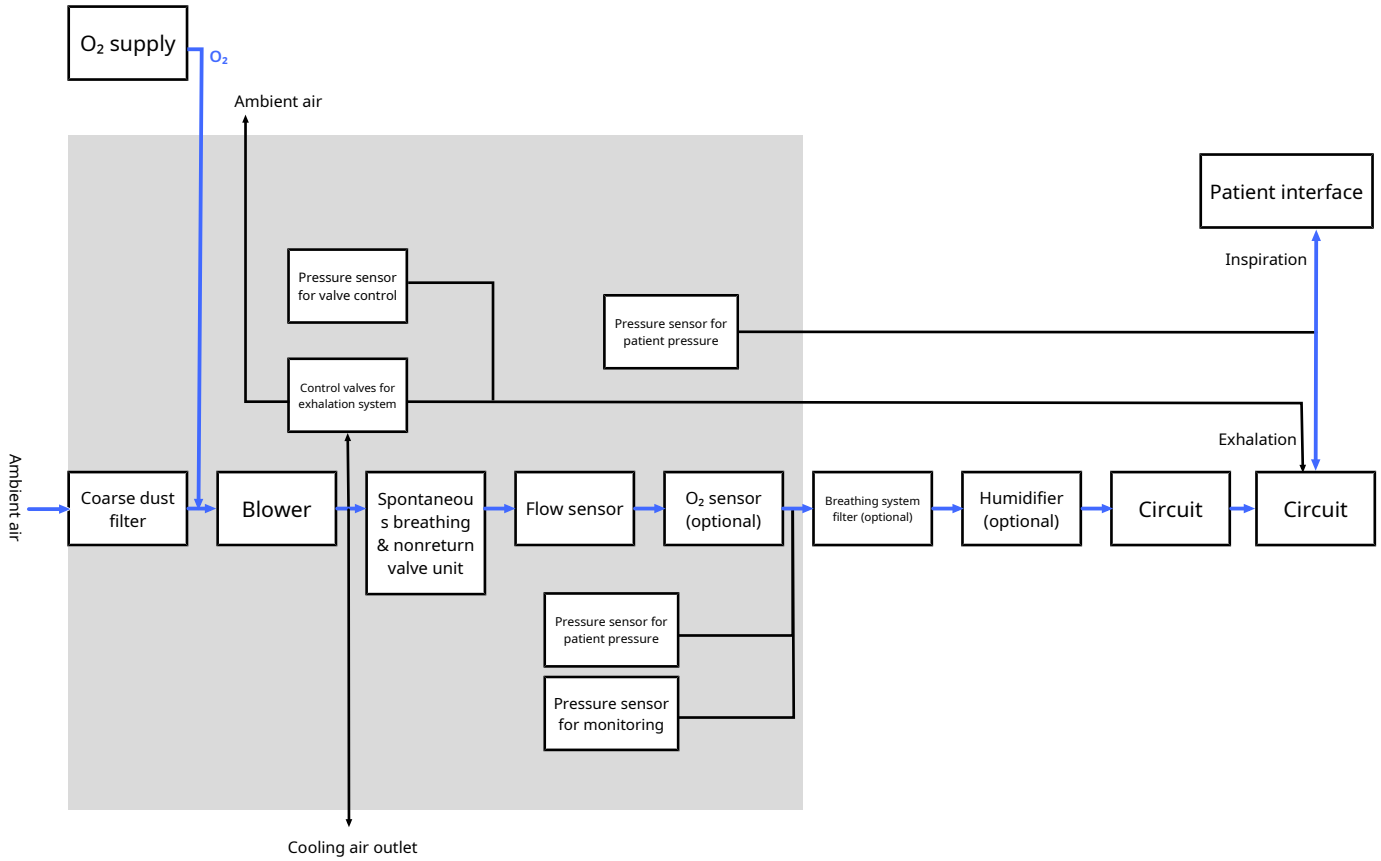

10.1.2 Double circuit

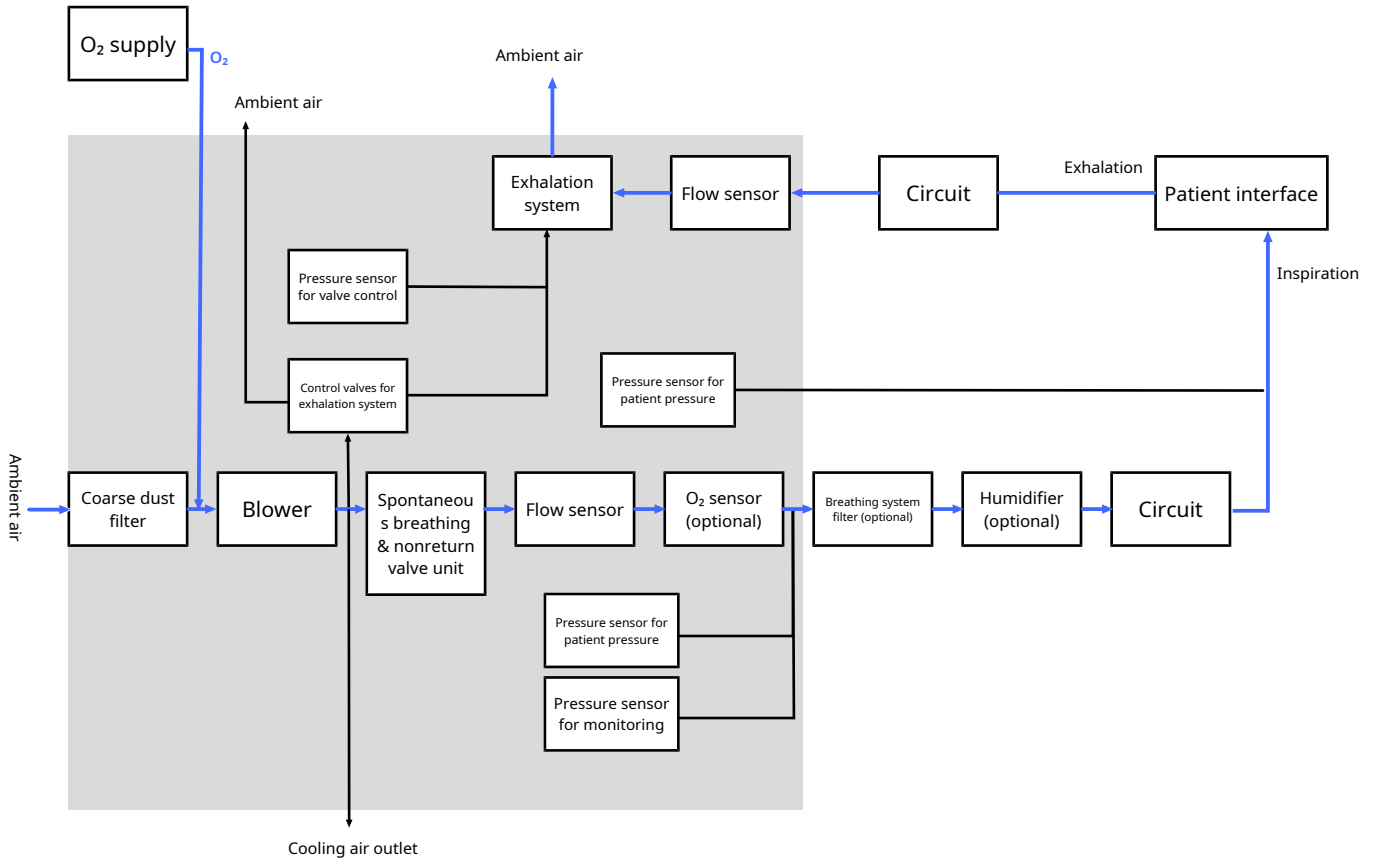

10.1.3 Leakage circuit

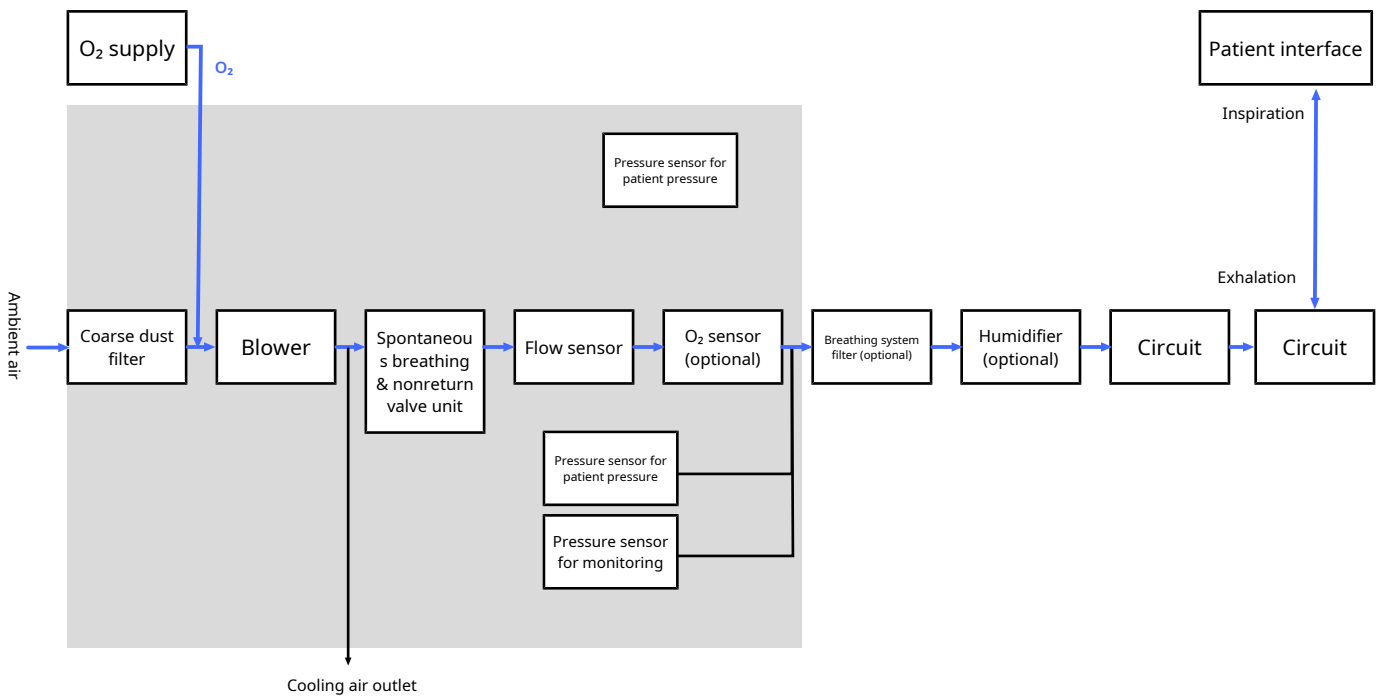

10.2 System resistances

The total pneumatic resistance of the connected circuit and of the connected accessories (e.g. humidifier, breathing system filter) between the device and the patient may not exceed the following value:

- Circuits with a diameter of 15 mm and 22 mm: Pressure reduction < 3.2 hPa at flow = 30 l/min (BTPS).

The pressure reduction values of the individual components can be added to form a total resistance value which must not exceed the above value.

Maximum error in pressure measurement: 0.0125 hPa

Article no.	Article name	Flow (BTPS) in l/min	Pressure reduction in hPa
LMT 31382	Single circuit with valve, 180 cm, 22 mm Ø	30	0.11
LMT 31383	Single circuit with valve, 90 cm, 15 mm Ø	30	0.46
LMT 31384	Single circuit with valve, heated (i), autofill chamber, 150 cm + 60 cm, 15 mm Ø	30	2.04
LMT 31577	Double circuit, 150 cm, 15 mm Ø	30	Inspiration tube: 0.76 Inspiration tube from patient to device: 0.92 Exhalation tube: 0.69
LMT 31581	Double circuit, 180 cm, 22 mm Ø	30	Inspiration tube: 0.17 Inspiration tube from patient to device: 0.24 Exhalation tube: 0.17
LMT 31582	Double circuit, heated (i+e), A-shaped adapter, autofill chamber, 150 cm + 60 cm, 15 mm Ø	30	Inspiration tube: 2.03 Inspiration tube from patient to device: 2.05 Exhalation tube: 2.06
LMT 31583	Double circuit, heated (i+e), A-shaped adapter, autofill chamber, 150 cm + 60 cm, 15 mm Ø	30	Inspiration tube: 0.22 Inspiration tube from patient to device: 0.32 Exhalation tube: 0.37
LMT 31386	Double circuit, heated (i+e), autofill chamber, 150 cm + 60 cm, 22 mm Ø	30	Inspiration tube: 0.17 Inspiration tube from patient to device: 0.16 Exhalation tube: 0.097
WM 27591	Teleflex Iso-Gard breathing system filter	2.5	0.06

Key performance characteristics to ISO 80601-2-72

- Accuracy of airway pressure

- Accuracy of the volume delivered in a single breath
- No faulty therapy parameter settings
- Functionality of alarms

10.3 Emission of electromagnetic interference

Measurements of interference emission	Compliance
HF emissions to CISPR 11	Group 1/Class B
Harmonic distortion (IEC 6100-3-2)	Class A
Voltage fluctuations and flicker (IEC 6100-3-3)	Complies
Conducted and radiated interference emissions for equipment in aircraft (RTCA DO-160G - Part 21, Category M)	Complies













10.4 Electromagnetic interference immunity











Interference immunity tests	Compliance level
Discharge of static electricity (ESD) to IEC 61000-4-2	± 8 kV contact discharge ± 15 kV air discharge
Radiated HF interference to IEC 61000-4-3	10 V/m 80 MHz to 2.7 GHz

Interference immunity tests	Compliance level
High-frequency electromagnetic fields in the immediate vicinity of wireless communication equipment (IEC 61000-4-3)	9 to 28 V/m* 385 MHz to 5.785 GHz* * Tested to IEC 60601-1-2:2020 Table 9
Electrical fast transients to IEC 61000-4-4	± 2 kV for power supply cables ± 1 kV for input and output cables
Surge immunity to IEC 61000-4-5	± 1 kV line to line
Conducted HF interference to IEC 61000-4-6	3 Vrms 150 kHz to 80 MHz 6 Vrms in ISM and amateur radio frequency bands between 150 kHz and 80 MHz
Magnetic field at power supply frequency (50/60 Hz) to IEC 61000-4-8	30A/m
Voltage dips/short interruptions and fluctuations in power supply to IEC 61000-4-11	0 % UT; 1/2 period 0 % UT; 1 period 70 % UT; 25/30 periods 0 % UT; 250/300 periods
Magnetic fields in close range (IEC 61000-4-39)	8 A/m at 30 kHz 65 A/m at 134.2 kHz 7.5 A/m at 13.56 MHz

10.5 Markings and symbols

The following markings and symbols may be applied to the device, accessories or packaging.

Symbol	Description
	Unique device identifier (uniform product code for medical devices)
	Order number
	Indicates the product is a medical device
	Manufacturer and, if necessary, date of manufacture
	Follow the instructions for use
	CE symbol (confirms that the product conforms to the applicable European directives/regulations)
	Permitted temperature range for transport and storage
	Permitted humidity range for transport and storage
	Pressure measuring tube connection
	Valve control tube connection
	Patient's exhaled air outlet on double circuit; do not block outlet
	Inlet; do not block openings

Symbol	Description
	Outlet
	Follow Instructions for Use
	Direct current: 12 V, 24 V or 48 V
TYPE	Type designation of the device
	Suitable for use in aircraft. Meets RTCA/DO-160G Section 21, Category M.
	Degree of protection against electric shock: Protection class II product
	Do not dispose of the product in domestic waste
IP22	Degree of protection against contact with a finger. Protection against vertically falling water drops when enclosure tilted up to 15°.
	Type BF application part
	Protect from moisture
	Fragile. Do not throw or drop
	Use multiple times on a single patient
	Not MR-proof: Do not use product in an MR (magnetic resonance) environment
LOT	Lot number

10.6 Scope of supply

10.6.1 Device without HFT mode

The parts below are included in the standard scope of supply:

Part	Article no.	LMT 31400-1110	LMT 31420-1110
Basic device without HFT mode	LMT 31430	X	X
Single circuit with valve, 180 cm, 22 mm Ø	LMT 31382	X	X
External power supply unit	LMT 31569	X	X
Power cord	WM 24177	X	X
Oxygen connecting bushing	WM 30669	X	X
Set, 12 pollen filters/fine filters	WM 29652	X	X
Set, 2 air filters/coarse dust filters	WM 29928	X	X
Protective bag	LMT 31417	X	X
USB-C flash drive	LMT 31414	X	X
Patient record	1P-10088	X	X
LM patient information	WM 28209	X	-
Set, documents in accordance with Medizinprodukte-Betreiberverordnung [German law governing health institutions using medical devices]: Medical devices manual, handover log	WM 15100	X	X
Final inspection log LM150TD	LMT 31588	X	X
Accessories bag	LMT 31440	X	X
Instructions for Use	Varies depending on language	X	X

10.6.2 Device with HFT mode

The parts below are included in the standard scope of supply:

Part	Article no.	LMT 31380-1110	LMT 31390-1110
Basic device with HFT mode	LMT 31410	X	X
Single circuit with valve, 180 cm, 22 mm Ø	LMT 31382	X	X
External power supply unit	LMT 31569	X	X
Power cord	WM 24177	X	X
Oxygen connecting bushing	WM 30669	X	X
Set, 12 pollen filters/fine filters	WM 29652	X	X
Set, 2 air filters/coarse dust filters	WM 29928	X	X

Part	Article no.	LMT 31380-1110	LMT 31390-1110
Protective bag	LMT 31417	X	X
USB-C flash drive	LMT 31414	X	X
Patient record	1P-10088	X	-
LM patient information	WM 28209	X	-
Set, documents in accordance with Medizinprodukte-Betreiberverordnung [German law governing health institutions using medical devices]: Medical devices manual, handover log	WM 15100	X	-
Final inspection log LM150TD	LMT 31588	X	X
Accessories bag	LMT 31440	X	X
Instructions for Use	Varies depending on language	X	X

10.7 Accessories and spare parts

Part	Article no.
Teleflex Iso-Gard breathing system filter	WM 27591
WILAsilent exhalation system	WM 27589
Silentflow 3 exhalation system	WM 25500
Single circuit with valve, 90 cm, 15 mm Ø	LMT 31383
Single circuit with valve, 180 cm, 22 mm Ø	LMT 31382
Single circuit with valve, heated (i), autofill chamber, 150 cm + 60 cm, 15 mm Ø	LMT 31384
Single circuit with valve, heated (i), autofill chamber, 150 cm + 60 cm, 22 mm Ø	LMT 31385
Double circuit, 150 cm, 15 mm Ø	LMT 31577
Double circuit, 180 cm, 22 mm Ø	LMT 31581
Double circuit, heated (i+e), autofill chamber, 150 cm + 60 cm, 22 mm Ø	LMT 31583
Double circuit, heated (i+e), A-shaped adapter, autofill chamber, 150 cm + 60 cm, 15 mm Ø	LMT 31582
Double circuit, heated (i+e), autofill chamber, 120 cm + 60 cm, 10 mm Ø	LMT 31386
Leakage circuit, 15 mm Ø	WM 29988
Leakage circuit, 22 mm Ø	WM 23962
Leakage circuit, autoclavable, 22 mm Ø	WM 24667
Leakage circuit, mouthpiece ventilation 15 mm Ø	WM 27651
Mouthpiece	LMT 27646
Leakage circuit, heated (i), autofill chamber, passive valve, 150 cm + 60 cm, 15 mm Ø for LM150TD	WM 271704
Leakage circuit, heated (i), autofill chamber, passive valve, 150 cm + 60 cm, 22 mm Ø for LM150TD	WM 271705

Part	Article no.
Set, 90° tube adapter	LMT 15984
Internal battery	LMT 31550
External battery	LMT 31540
Battery charger	LMT 31594
External power supply unit	LMT 31569
Set, hospital trolley consisting of: Trolley 2.0 Set, plate for trolley 2.0 Set, device plate for device type LM150TD Power supply holder for trolley 2.0 Oxygen cylinder holder for trolley 2.0 Circuit holder for trolley 2.0	LMT 31370
Set, home care trolley consisting of: Trolley 2.0 Set, plate for trolley 2.0 Set, device plate for device type LM150TD Power supply holder for trolley 2.0	LMT 31360
Set, plate for trolley 2.0	LMT 31371
Set, device plate for device type LM150TD	LMT 31359
VENTIremote alarm LM150TD, 10 m	LMT 31560
VENTIremote alarm LM150TD, 30 m	LMT 31570
Cable, 10 m, nurse call for LM150TD	LMT 31510
Cable, 30 m, nurse call for LM150TD	LMT 31520
prismaTS / prismaTslab software	WM 93331
USB-C flash drive	LMT 31414
COM cable for monitor	LMT 31578
LUISA app	-
FiO ₂ cell, complete	LMT 31502
Mobility bag, LM150TD	LMT 31554
Exhalation module (disposable)	LMT 31404
Exhalation module (autoclavable)	LMT 31413
Set, membrane for expiration module	LMT 15986
Oxygen connecting bushing	WM 30669
Protective bag	LMT 31010
Accessories bag	LMT 31440
Set, 2 air filters/coarse dust filters	WM 29928
Set, 12 pollen filters/fine filters	WM 29652
SpO ₂ /Xpod® cable	LMT 31593
SpO ₂ sensor size S	LMT 31580
SpO ₂ sensor size M	LMT 31396
SpO ₂ sensor size L	LMT 31388

10.8 Declaration of Conformity

The manufacturer Löwenstein Medical Technology GmbH + Co. KG (Kronsaalsweg 40, 22525 Hamburg, Germany) hereby declares that the product complies with the relevant provisions of the Medical Device Regulations (EU) 2017/745. The unabridged text of the Declaration of Conformity can be found on the manufacturer's website.

10.9 Warranty

Löwenstein Medical Technology gives the purchaser of a new original Löwenstein Medical Technology product and of a spare part fitted by Löwenstein Medical Technology a limited manufacturer warranty in accordance with the warranty conditions applicable to the product in question and in accordance with the warranty periods from date of purchase listed below. The warranty conditions are available on the manufacturer's website. We will also send you the warranty conditions on request.

Please bear in mind that any claim under warranty and liability shall be void if neither the accessories recommended in the instructions for use nor genuine spare parts are used.

In the event of a claim under warranty, contact your specialist dealer.

Product	Warranty periods
Masks including accessories	6 months
Devices including accessories	2 years
Batteries (unless quoted differently in the technical documentation), sensors, circuits	6 months
Disposable products	None

CE 0197

 **Manufacturer**
Löwenstein Medical
Technology GmbH + Co.KG
Kronsaalweg 40
22525 Hamburg, Germany
T: +49 40 54702-0
F: +49 40 54702-461
www.loewensteinmedical.com



LMT 68691

LÖWENSTEIN
medical